

ALUMIX *Decorative profiles*



**FBS Profilati srl, fondata nel 1999
dalla seconda generazione
imprenditoriale della nostra famiglia,
è un'azienda dinamica che trae la sua
essenza dal concept del "MADE IN ITALY"
tramandato attraverso l'esperienza
delle sue figure storiche che dal 1964
si dedicano con entusiasmo alla
progettazione e produzione di profili
decorativi in alluminio e serrandine.
Nella nostra sede di Settimo Milanese,
che si sviluppa su una superficie complessiva
di 5000 m², creiamo prodotti sempre
all'avanguardia e al passo con le più
moderne tendenze del mondo del design
per arredamento di interni a partire
da materie prime di qualità eccellente.**

FBS Profilati srl, founded in 1999 by the second managerial generation of our family, is a dynamic company that draws its essence from the concept of "MADE IN ITALY" handed down through the experience of senior figures who have enthusiastically committed to designing and manufacturing aluminium decorative profiles and tambour doors since 1964.

In our headquarters in Settimo Milanese, stretching over a 5000m² area, we create forefront and contemporary up-to-date products with modern furniture design trends, exclusively using excellent raw materials.

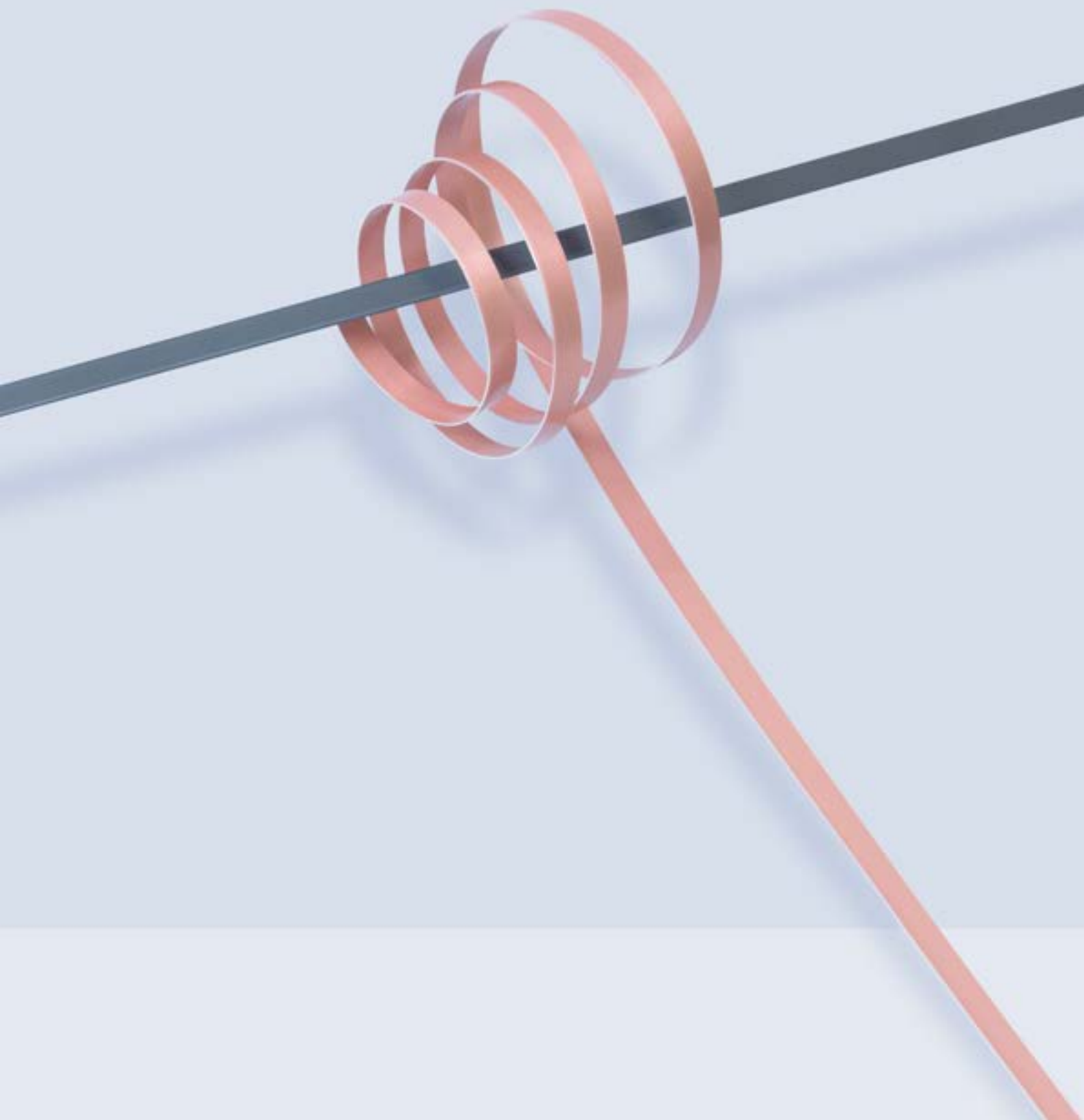

ALUMIX

Un'ampia gamma di profili decorativi in alluminio per l'industria dell'arredo. FBS Profilati srl produce e fornisce profili in alluminio standard e speciali da catalogo, oppure personalizzati su disegno e specifiche del cliente, anche con caratteristiche tecniche e dimensionali molto elevate.

I profili in alluminio piegati a freddo prodotti da FBS Profilati srl sono forniti in più di 20 diverse finiture. Quest'ultime si raggruppano essenzialmente in due macro categorie: le finiture di anodizzazione e quelle di verniciatura. Durante il processo di produzione, la scelta della profilatura a freddo ha permesso di contenere al minimo l'impatto ambientale poiché il materiale viene lavorato a temperatura ambiente senza la necessità di macchinari aggiuntivi.

A wide range of standard and tailor made decorative aluminium profiles for the design industry. FBS Profilati produces and supplies standard and special aluminum profiles, from stock items to completely customized ones according to the customer's design and specifications, even with particularly high technical and size characteristics.

The roll formed aluminium profiles produced by FBS Profilati are supplied in more than 20 different finishes which are divided in two macro categories: anodized or prepainted. During the production process, the choice of environmentally friendly roll forming technology has made it possible to keep the environmental impact to the minimum, since the material is formed in cold conditions without the need for extra tooling.



lavorazioni su misura
custom made products

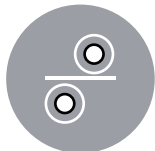

profilatura a freddo
roll formed profiling



progettazione di nuovi prodotti
development of new products



materiali riciclabili
recyclable materials

Profili decorativi

Decorative inserts

ESTRUSI	pag. 9
<i>EXTRUDED</i>	
PROFILATI A FREDDO	pag. 11
<i>ROLL-FORMED PROFILES</i>	
BANDELLE	pag. 13
<i>STRIPS</i>	
PROFILI AUTOADESIVI PER VETRO	pag. 17
<i>SELF-ADHESIVE PROFILES FOR GLASS</i>	
PROFILI A T	pag. 23
<i>T-PROFILES</i>	
PROFILI PER BORDATURA	pag. 26
<i>BORDER PROFILES</i>	
PROFILI SPECIALI	pag. 31
<i>SPECIAL PROFILES</i>	
WAY Design Gio Tiroto	pag. 32
FERMAVETRI	pag. 38
<i>GLASS FIX</i>	
PROFILI AUTOADESIVI	pag. 39
<i>SELF-ADHESIVE PROFILES</i>	
PROFILI PER CORNICI	pag. 40
<i>STRUCTURAL FRAMES</i>	
PROFILO PER RIPIANO PORTAVALIGIE	pag. 42
<i>PROFILE FOR LUGGAGE RACK</i>	
PROFILO PORTA POSTER	pag. 43
<i>POSTER HANGING PROFILE</i>	

Finiture e specifiche tecniche

pag. 44

Finishing and technical details

Troncatori

pag. 45

Cutting machines



PROFILI DECORATIVI PER PORTE, BOISERIE E MOBILI

DECORATIVE PROFILES FOR DOORS, BOISERIE AND FURNITURE

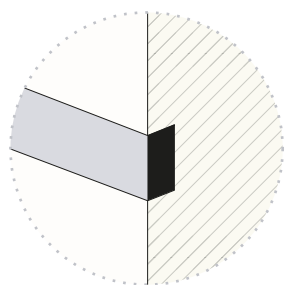

ESTRUSI

EXTRUDED

Tipologia di fissaggio ad incasso

Fixing procedure: inset

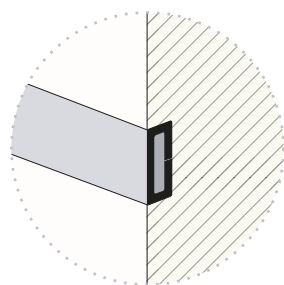

PROFILATI A FREDDO

ROLL-FORMED PROFILES

Tipologia di fissaggio ad incasso

Fixing procedure: inset

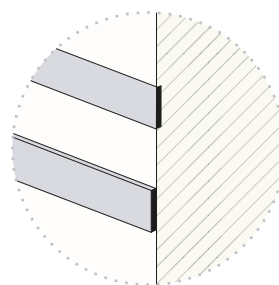

BANDELLE

STRIPS

Tipologia di fissaggio ad incasso o esterno

Fixing procedure: inset or surface mounted

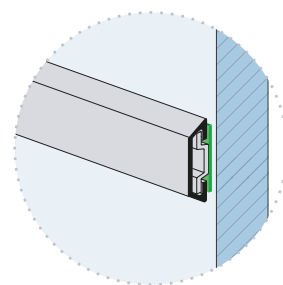

PROFILATI DECORATIVI

DECORATIVE PROFILES

Tipologia di fissaggio ad incasso o esterno

Fixing procedure: inset or surface mounted

Prezzo Price



Tenuta Holding



Finiture Finishing

ANODIZZATI

ANODIZED

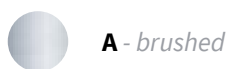

A - brushed



B3 - mill gold



A2 - inox brushed



RA - copper



B - mill finish



RA2 - polished copper

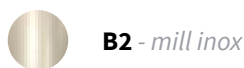

B2 - mill inox



D - chrome



SN - sat nat



D6 - brass gold

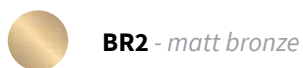

BR2 - matt bronze



D2 - polished gold

PREVERNICIATI

PREPAINTED



M3 - polished white



L1 - polished black



U9 - anthracite

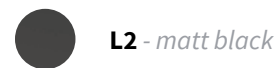

L2 - matt black



U5 - alumatt

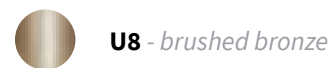

U8 - brushed bronze



U6 - inox



M4 - matt white



U7 - olive green



45

ESTRUSI EXTRUDED

Profili in alluminio estruso
da incasso per porte,
boiserie e mobili

*Extruded inset aluminium
profiles for doors, boiserie
and furniture*

Possibilità di fornire i profili con
biadesivo applicato sul retro
*It is possible to provide profiles with
self-adhesive tape pre-applied on
the back*

Finiture disponibili Available finishing

ANODIZZATI ANODIZED

-  **SN** - sat nat
-  **D** - chrome
-  **D6** - brass gold
-  **L2** - matt black

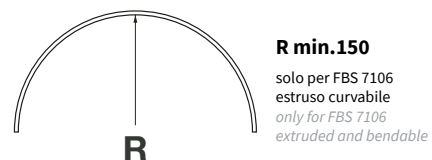

Modelli Options

misure in mm
dimensions in mm

CODICE
CODE

CODICE
CODE

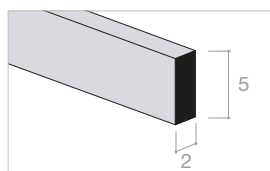

FBS 7520
Aste standard mm 2500
Standard bars mm 2500

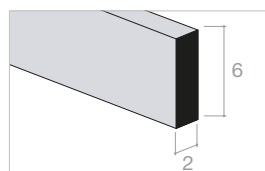

FBS 7106
Estruso curvabile
Extruded bendable
Aste standard mm 2500 e 3000
Standard bars mm 2500 and 3000

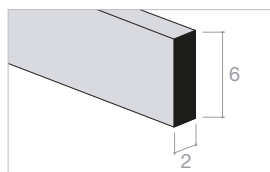

FBS 7106
Aste standard mm 2500 e 3000
Standard bars mm 2500 and 3000

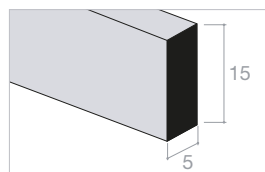

FBS 7215
Aste standard mm 3000
Standard bars mm 3000

Possibilità di personalizzare lo spessore di anodizzazione e la tipologia di biadesivo secondo specifiche esigenze
It is possible to customise the anodizing thickness and the type of self-adhesive tape according to specific requirements



PROFILATI A FREDDO

ROLL-FORMED PROFILES

Profili in alluminio
ideali per la decorazione
di porte, boiserie e arredo
*Roll-formed aluminium
profiles for doors, boiserie
and furniture*

Lunghezza barre 3000 mm
Possibilità di fornire i profili
tagliati a misura
*Bar length 3000 mm
Cut to size profiles are available*

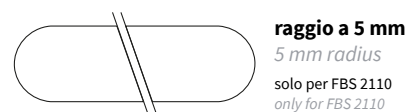
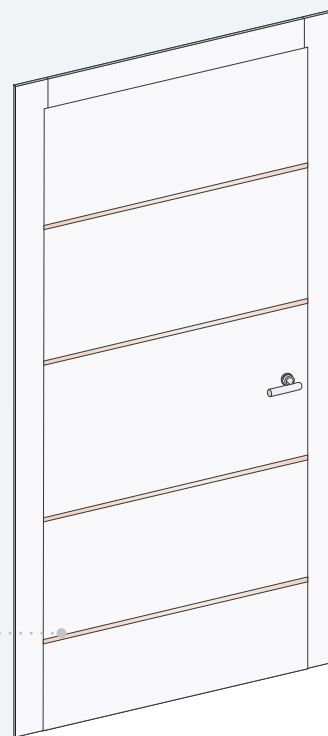
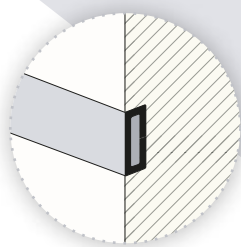

Modelli *Options*

misure in mm
dimensions in mm

CODICE
CODE

CODICE
CODE

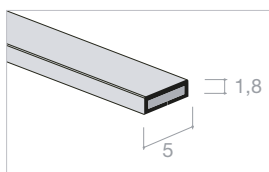

FBS 2105 ST

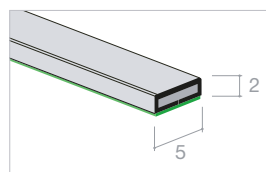

**FBS 2105 BD
BIADESIVO**
SELF-ADHESIVE

- 100% Alluminio
100% Aluminium
- Biadesivo
Self-adhesive

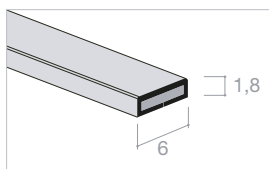

FBS 2106 ST

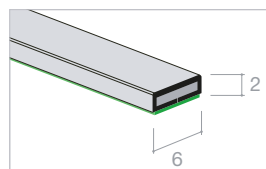

**FBS 2106 BD
BIADESIVO**
SELF-ADHESIVE

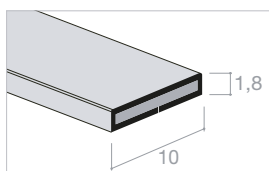

FBS 2110 ST

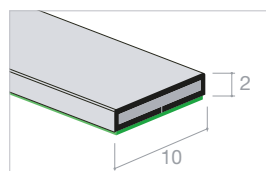

**FBS 2110 BD
BIADESIVO**
SELF-ADHESIVE

PROFILATI A FREDDO WIND

WIND ROLL-FORMED PROFILES

Profili in alluminio WIND -
microforato da incasso per
porte, boiserie e arredo
*WIND micro-perforated
roll-formed aluminium
profiles for doors, boiserie
and furniture*

Lunghezza barre 3000 mm
Possibilità di fornire i profili
tagliati a misura
*Bar length 3000 mm
Cut to size profiles are available*

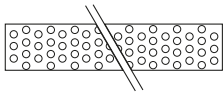
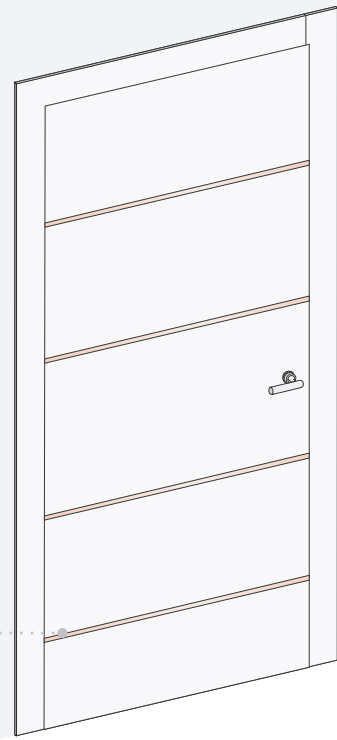
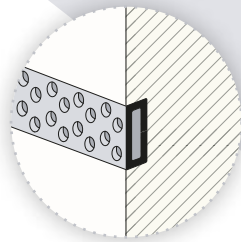

WIND
taglio a 90°
90° cut

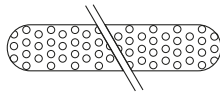

raggio a 3 mm
3 mm radius
solo per FBS 2106
only for FBS 2106

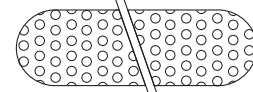

raggio a 5 mm
5 mm radius
solo per FBS 2110
only for FBS 2110

Modelli *Options*

misure in mm
dimensions in mm

CODICE
CODE

CODICE
CODE

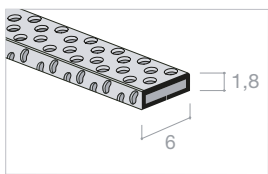

FBS 2106 WIND ST

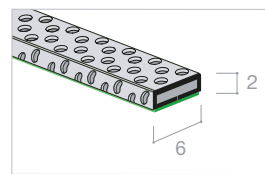

FBS 2106 BD
WIND BIADESIVO
SELF-ADHESIVE

100% Alluminio
100% Aluminium
Biadesivo
Self-adhesive

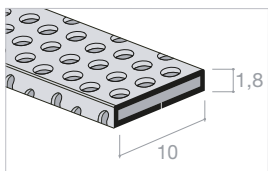

FBS 2110 WIND ST

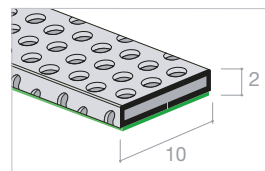

FBS 2110 BD
WIND BIADESIVO
SELF-ADHESIVE

Combinazioni colori *Colour combinations*

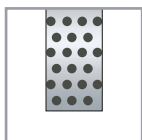

SN WIND
L2

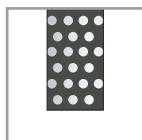

SN WIND
L2

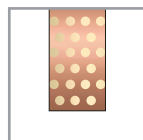

RA WIND
B3

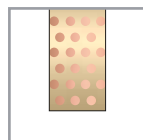

B3 WIND
RA

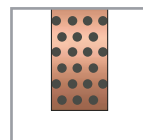

RA WIND
L2

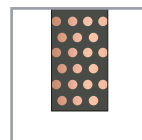

L2 WIND
RA

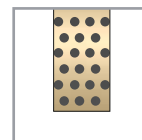

B3 WIND
U9

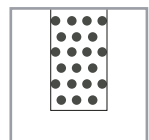

M1 WIND
L2

BANDELLE STRIPS

Bandelle autoadesive per
porte, infissi e arredamento
*Self-adhesive strips for doors,
window frames and furniture*

Lunghezza barre 3000 mm
Possibilità di fornire i profili
tagliati a misura o in bobine di
lunghezza variabile
*Bar length 3000 mm
It is possible to provide strips cut to
size or in coils of variable lengths*

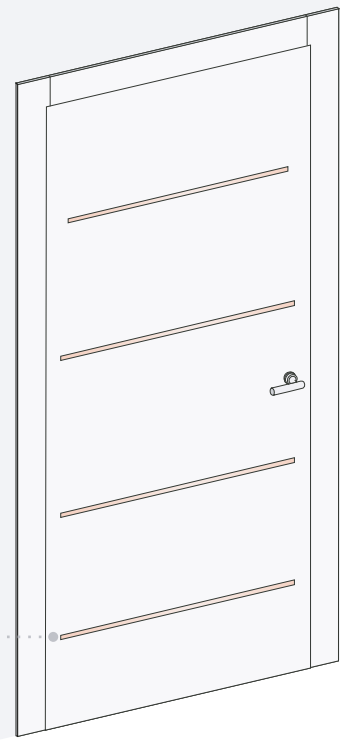
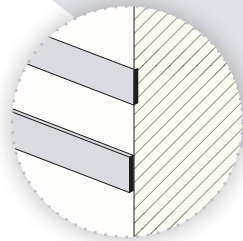
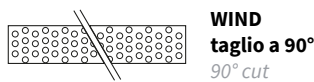

Modelli *Options*

misure in mm
dimensions in mm

100% Alluminio
100% Aluminium
Biadesivo
Self-adhesive

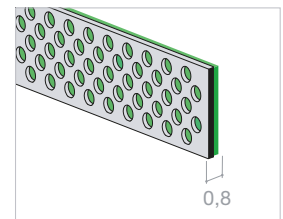
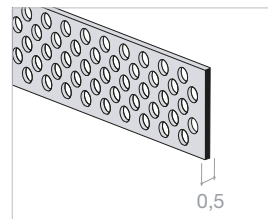
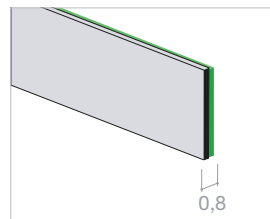
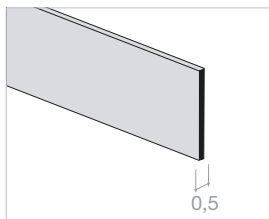

BANDELLE ST STANDARD STRIPS

BANDELLE BD SELF-ADHESIVE STRIPS

BANDELLE WIND ST STANDARD WIND STRIPS

BANDELLE WIND BD SELF-ADHESIVE WIND STRIPS

CODICE CODE	MISURE MEASUREMENTS
FBS 8006 ST	H: 6 mm
FBS 8008 ST	H: 8 mm
FBS 8010 ST	H: 10 mm
FBS 8012 ST	H: 12 mm
FBS 8014 ST	H: 14 mm
FBS 8016 ST	H: 16 mm
FBS 8018 ST	H: 18 mm
FBS 8020 ST	H: 20 mm
FBS 8022 ST	H: 22 mm
FBS 8024 ST	H: 24 mm
FBS 8030 ST	H: 30 mm
FBS 8040 ST	H: 40 mm
FBS 8060 ST	H: 60 mm

CODICE CODE	MISURE MEASUREMENTS
FBS 8006 BD	H: 6 mm
FBS 8008 BD	H: 8 mm
FBS 8010 BD	H: 10 mm
FBS 8012 BD	H: 12 mm
FBS 8014 BD	H: 14 mm
FBS 8016 BD	H: 16 mm
FBS 8018 BD	H: 18 mm
FBS 8020 BD	H: 20 mm
FBS 8022 BD	H: 22 mm
FBS 8024 BD	H: 24 mm
FBS 8030 BD	H: 30 mm
FBS 8040 BD	H: 40 mm
FBS 8060 BD	H: 60 mm

CODICE CODE	MISURE MEASUREMENTS
FBS 8006 ST	H: 6 mm
FBS 8008 ST	H: 8 mm
FBS 8010 ST	H: 10 mm
FBS 8012 ST	H: 12 mm
FBS 8014 ST	H: 14 mm
FBS 8016 ST	H: 16 mm
FBS 8018 ST	H: 18 mm
FBS 8020 ST	H: 20 mm
FBS 8022 ST	H: 22 mm
FBS 8024 ST	H: 24 mm
FBS 8030 ST	H: 30 mm
FBS 8040 ST	H: 40 mm
FBS 8060 ST	H: 60 mm

CODICE CODE	MISURE MEASUREMENTS
FBS 8006 BD	H: 6 mm
FBS 8008 BD	H: 8 mm
FBS 8010 BD	H: 10 mm
FBS 8012 BD	H: 12 mm
FBS 8014 BD	H: 14 mm
FBS 8016 BD	H: 16 mm
FBS 8018 BD	H: 18 mm
FBS 8020 BD	H: 20 mm
FBS 8022 BD	H: 22 mm
FBS 8024 BD	H: 24 mm
FBS 8030 BD	H: 30 mm
FBS 8040 BD	H: 40 mm
FBS 8060 BD	H: 60 mm

Altre misure di larghezza su richiesta fino a 150 mm - disponibile
Other widths upon request up to 150 mm



BANDELLE STRIPS

Bandelle autoadesive per
porte, infissi e arredamento
*Self-adhesive strips for doors,
window frames and furniture*

Possibilità di fornire le bandelle
tagliate a misura
Cut to size strips are available

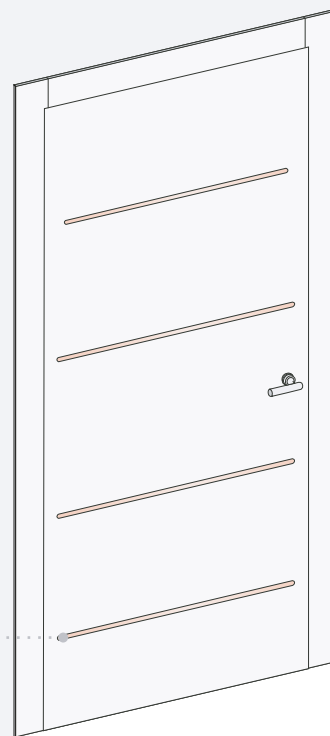
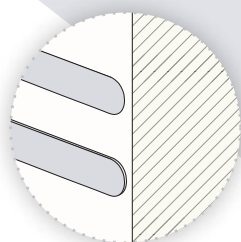
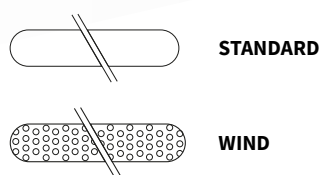

Modelli *Options*

misure in mm
dimensions in mm

100% Alluminio
100% Aluminium
Biadesivo
Self-adhesive

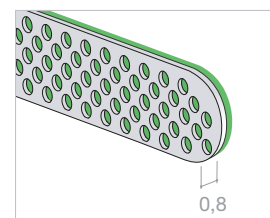
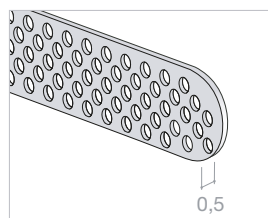
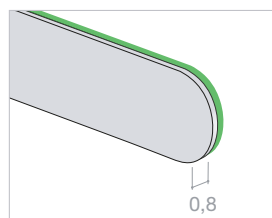
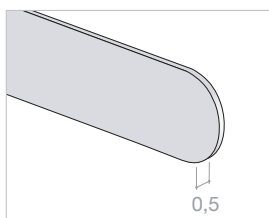

BANDELLE STANDARD *STANDARD STRIPS*

CODICE
CODE

MISURE
MEASUREMENTS

FBS 8006 ST H: 6 mm
R: 3 mm

FBS 8008 ST H: 8 mm
R: 4 mm

FBS 8010 ST H: 10 mm
R: 5 mm

BANDELLE BIADESIVO *SELF-ADHESIVE STRIPS*

CODICE
CODE

MISURE
MEASUREMENTS

FBS 8006 BD H: 6 mm
R: 3 mm

FBS 8008 BD H: 8 mm
R: 4 mm

FBS 8010 BD H: 10 mm
R: 5 mm

BANDELLE WIND ST *STANDARD WIND STRIPS*

CODICE
CODE

MISURE
MEASUREMENTS

FBS 8006 ST H: 6 mm
R: 3 mm

FBS 8008 ST H: 8 mm
R: 4 mm

FBS 8010 ST H: 10 mm
R: 5 mm

BANDELLE WIND BD *SELF-ADHESIVE WIND STRIPS*

CODICE
CODE

MISURE
MEASUREMENTS

FBS 8006 BD H: 6 mm
R: 3 mm

FBS 8008 BD H: 8 mm
R: 4 mm

FBS 8010 BD H: 10 mm
R: 5 mm



PROFILI AUTOADESIVI PER VETRO

SELF-ADHESIVE PROFILES FOR GLASS

Profili con biadesivo
per porte a vetro
*Self-adhesive profiles
for glass doors*

Lunghezza barre 3000 mm
Possibilità di fornire i profili
tagliati a misura
*Bar length 3000 mm
Cut to size profiles are available*

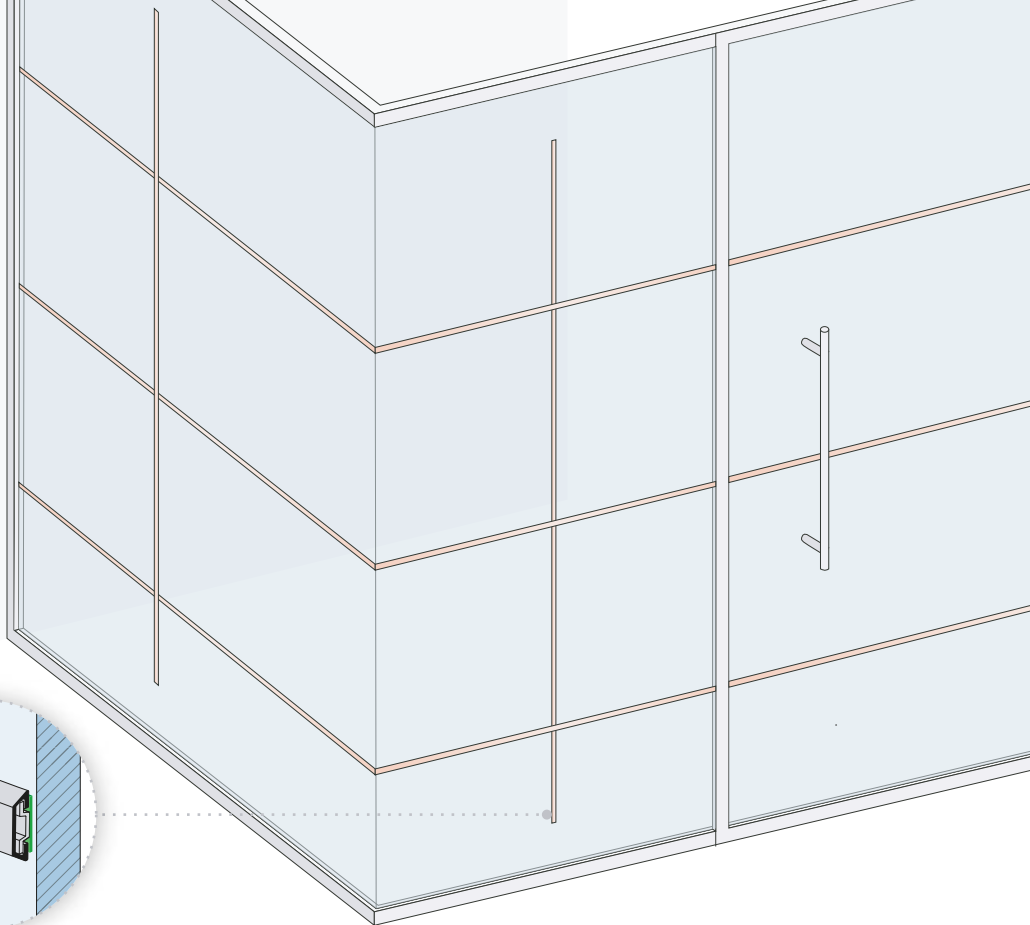
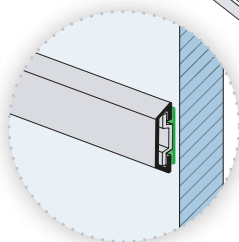

Modelli *Options*

misure in mm
dimensions in mm

CODICE
CODE

FISSAGGIO
MOUNTING

○ 100% Alluminio
100% Aluminium
● Biadesivo
Self-adhesive

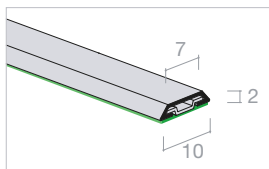

FBS 2038

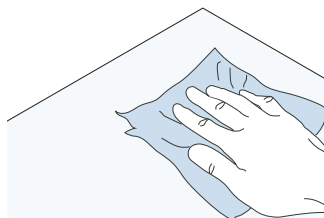

1. Pulire accuratamente
la superficie
*Thoroughly clean
the surface*

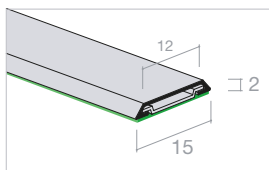

FBS 2040

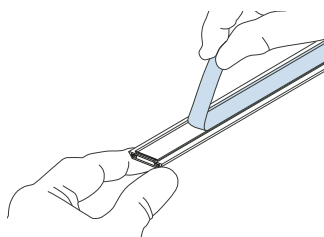

2. Rimuovere il film
del biadesivo
*Remove film from
the self-adhesive strip*

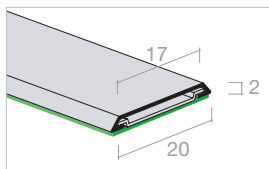

FBS 2041

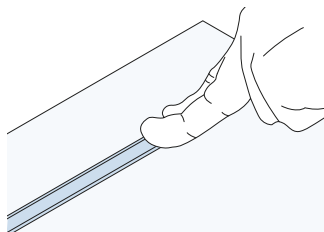

3. Incollare con una
leggera pressione il profilo
sulla superficie
*Stick the profile onto
the surface applying
a light pressure*

Accessorio per FBS 2038BD
Accessory for FBS 2038BD

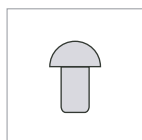

FBS 9237





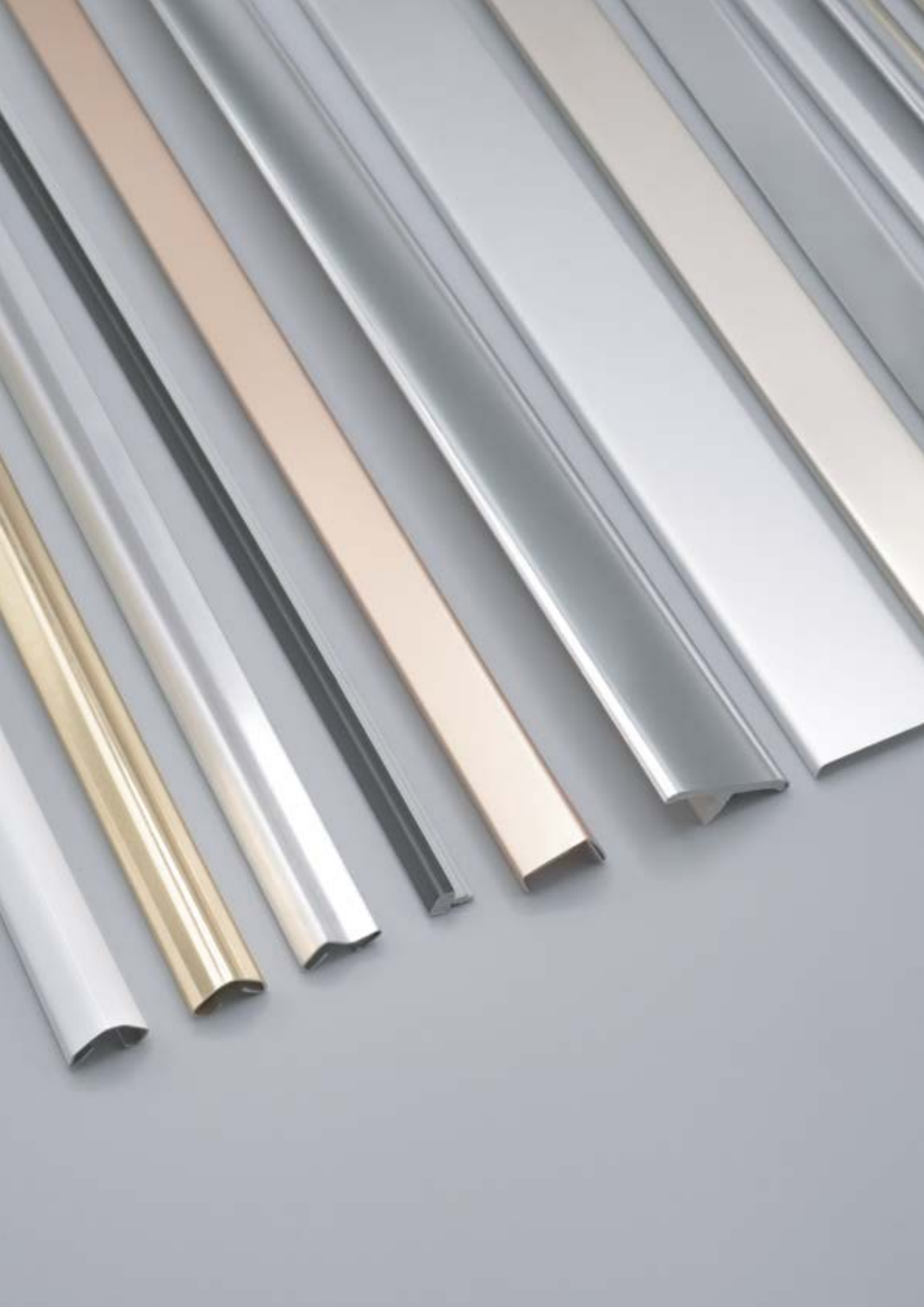

PROFILI DECORATIVI DI FINITURA

DECORATIVE TRIM PROFILES

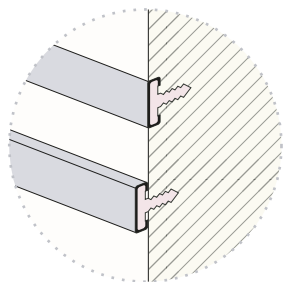

PROFILATI A T

T-PROFILES

Tipologia di fissaggio
a collante

Fixing procedure:
by glue

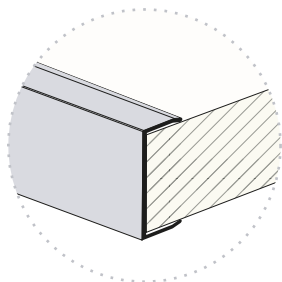

BORDI

BORDERS

Tipologia di fissaggio
a incastro

Fixing procedure:
dovetailing

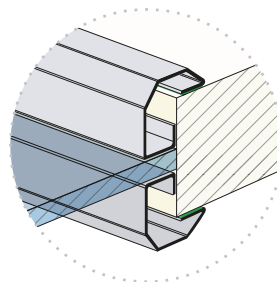

FERMAVETRI

GLASS FIX

Tipologia di fissaggio
autoadesivo

Fixing procedure:
self-adhesive

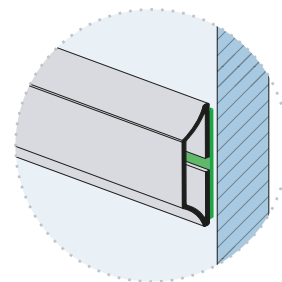

PROFILATI DECORATIVI PER VETRO

DECORATIVE PROFILES
FOR GLASS

Tipologia di fissaggio
autoadesivo

Fixing procedure:
self-adhesive

Finiture *Finishing*

ANODIZZATI

ANODIZED

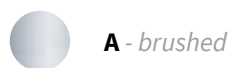

A - brushed



B3 - mill gold



A2 - inox brushed



RA - copper



B - mill finish



RA2 - polished copper

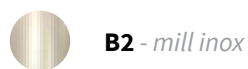

B2 - mill inox



D - chrome



SN - sat nat



D6 - brass gold



BR2 - matt bronze



D2 - polished gold

PREVERNICIATI

PREPAINTED



M3 - polished white



L1 - polished black



U9 - anthracite



L2 - matt black



U5 - alumatt

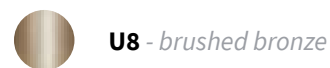

U8 - brushed bronze



U6 - inox



M4 - matt white



U7 - olive green



PROFILI A T

T-PROFILES

Profili in alluminio con gambo a T.
Anima in polistirene rivestita in alluminio. Ideale per porte, boiserie e arredo

*T moulded aluminium profiles.
Aluminum coated polystyrene core. Ideal for doors, boiserie and furniture*

Lunghezza barre 3000 mm
Possibilità di fornire i profili tagliati a misura
*Bar length 3000 mm
Cut to size profiles are available*

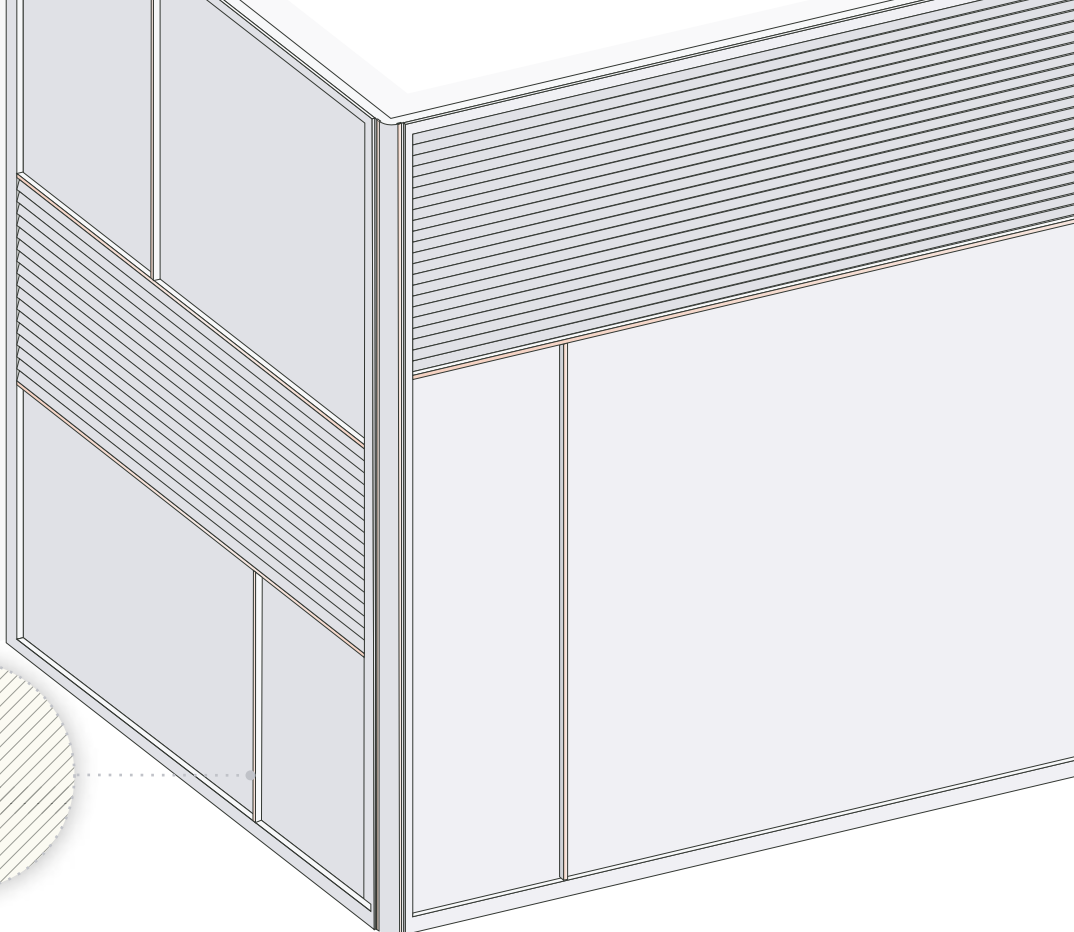
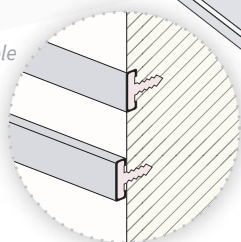

Modelli Options

misure in mm
dimensions in mm

CODICE
CODE

CODICE
CODE

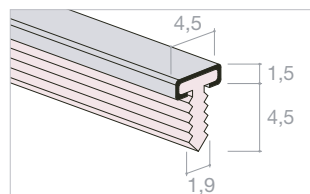

FBS 3108

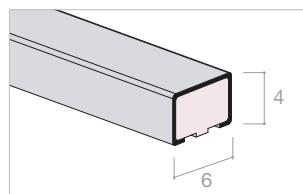

FBS 3304

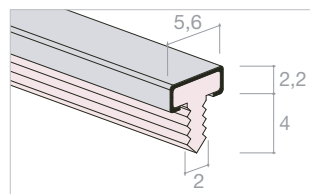

FBS 3205

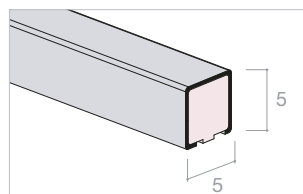

FBS 3382

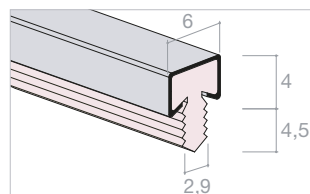

FBS 3006

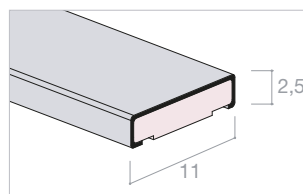

FBS 3112

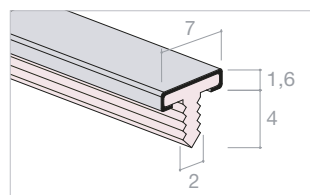

FBS 3338

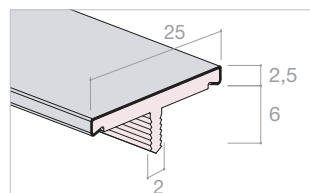

FBS 3415

-  Polistirene
Polystyrene
-  100% Alluminio
100% Aluminium

PROFILI A T

T-PROFILES

Profili in alluminio con gambo a T.
Anima in polistirene rivestita in alluminio. Ideale per porte, boiserie e arredo

*T moulded aluminium profiles
Aluminum coated polystyrene core.
Ideal for doors, boiserie and furniture*

Lunghezza barre 3000 mm
Possibilità di fornire i profili tagliati a misura
*Bar length 3000 mm
Cut to size profiles are available*

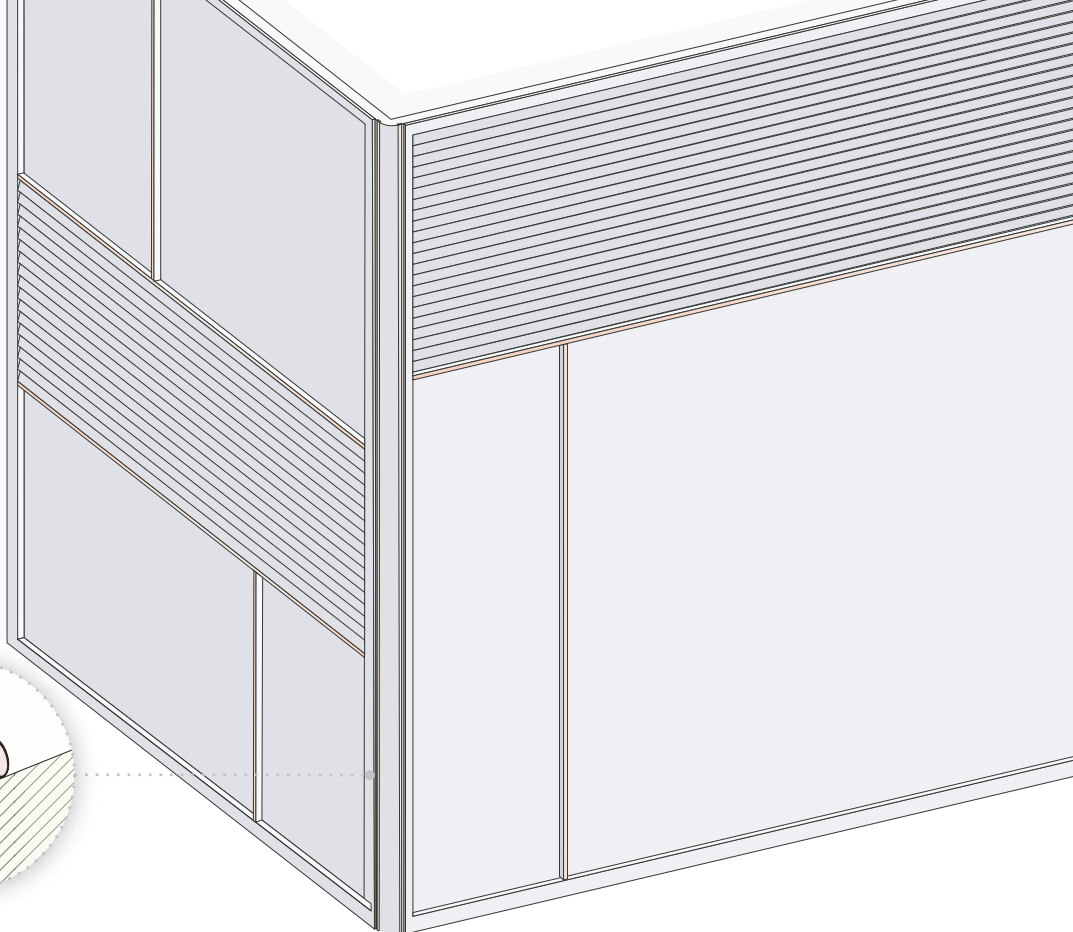
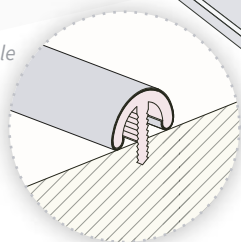

Modelli Options

misure in mm
dimensions in mm

CODICE
CODE

CODICE
CODE

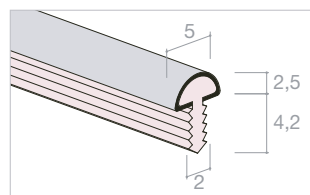

FBS 3216

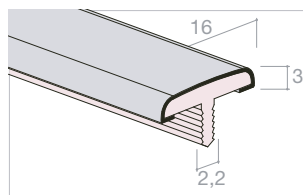

FBS 3016

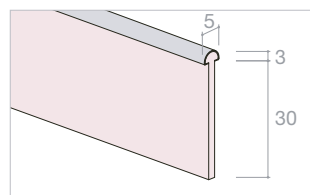

FBS 3556

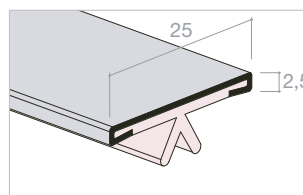

FBS 3535

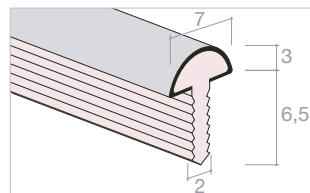

FBS 3219

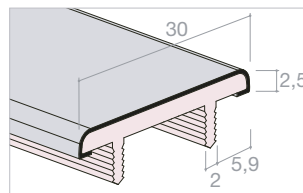

FBS 3537

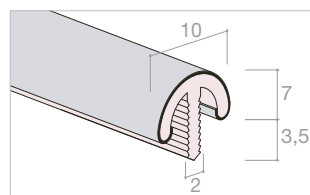

FBS 3416

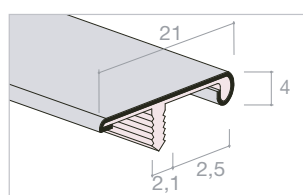

FBS 3411

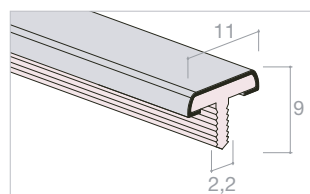

FBS 3011

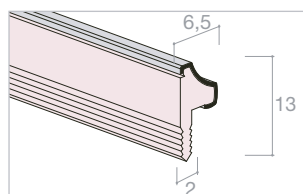

FBS 3502

-  Polistirene
Polystyrene
-  100% Alluminio
100% Aluminium

PROFILI A T

T-PROFILES

Profili in alluminio con gambo a T.
 Anima in polistirene rivestita in alluminio. Ideale per pannelli
T moulded aluminium profiles
Aluminum coated polystyrene core.
Ideal for panels

Lunghezza barre 3000 mm
 Possibilità di fornire i profili
 tagliati a misura
Bar length 3000 mm
Cut to size profiles are available

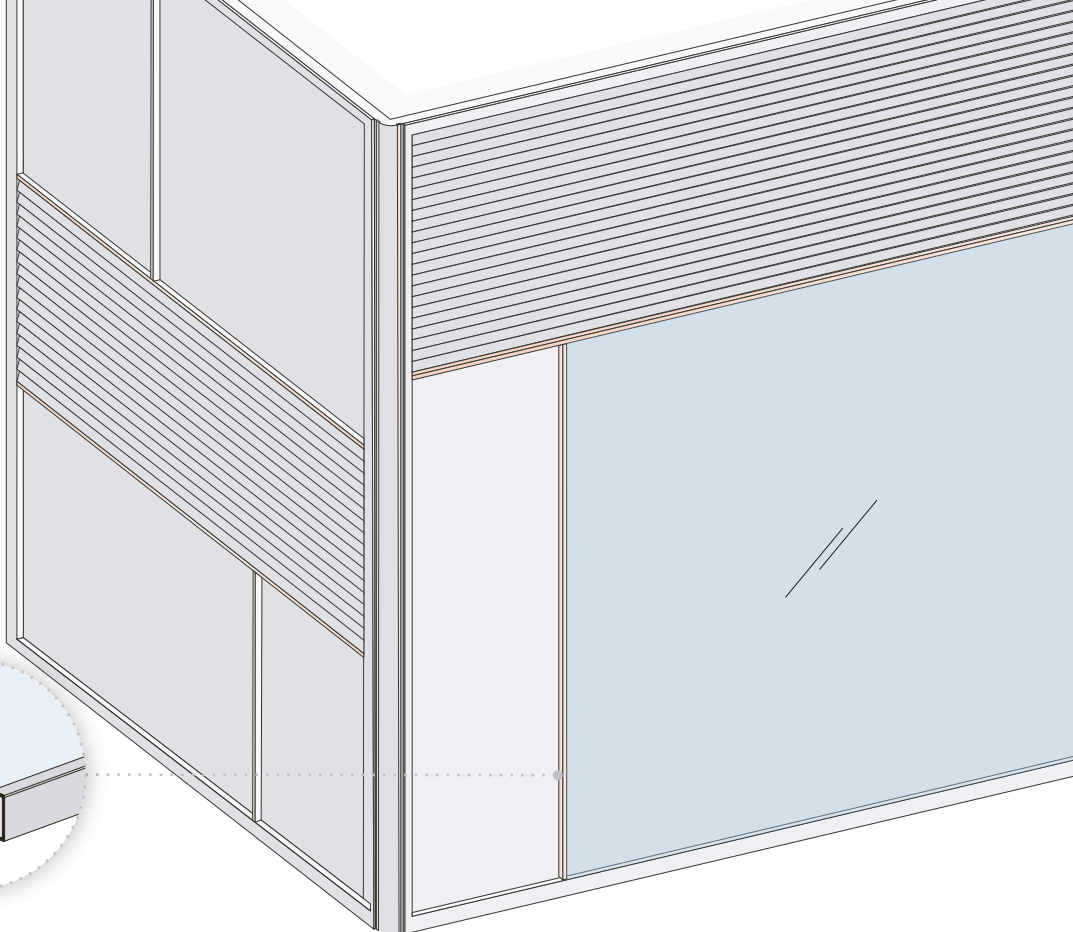
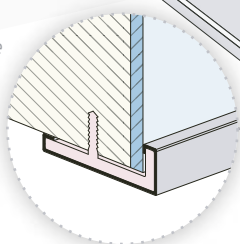

Modelli Options

misure in mm
 dimensions in mm

CODICE
 CODE

CODICE
 CODE

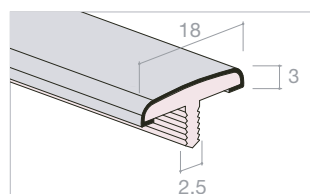

FBS 3018

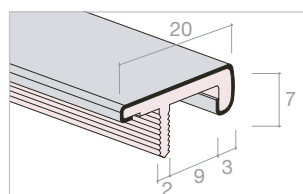

FBS 3228

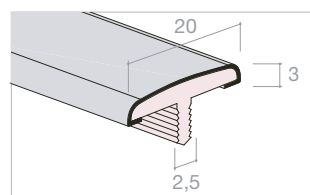

FBS 3020

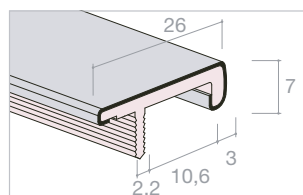

FBS 3022

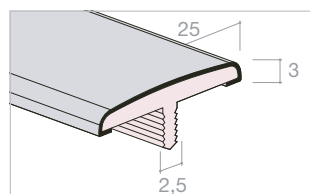

FBS 3025

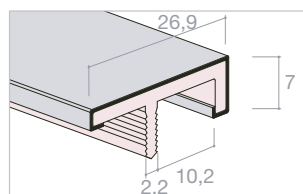

FBS 3023

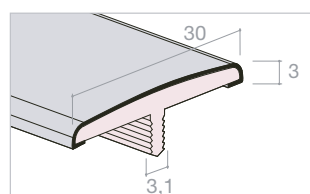

FBS 3030

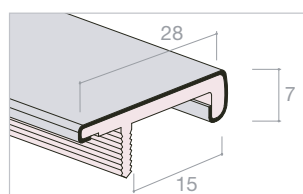

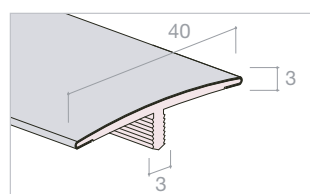

FBS 3270

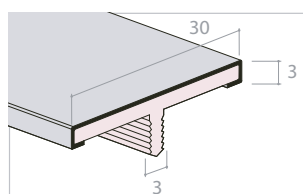

FBS 3526



FBS 3430

-  Polistirene
Polystyrene
-  100% Alluminio
100% Aluminium

PROFILI PER BORDATURA

BORDER PROFILES

Profili in alluminio per
bordatura vetri e pannelli
*Aluminium border profiles
for doors, cupboard doors
and glass partitions*

Lunghezza barre 3000 mm
Possibilità di fornire i profili
tagliati a misura
*Bar length 3000 mm
Cut to size profiles are available*

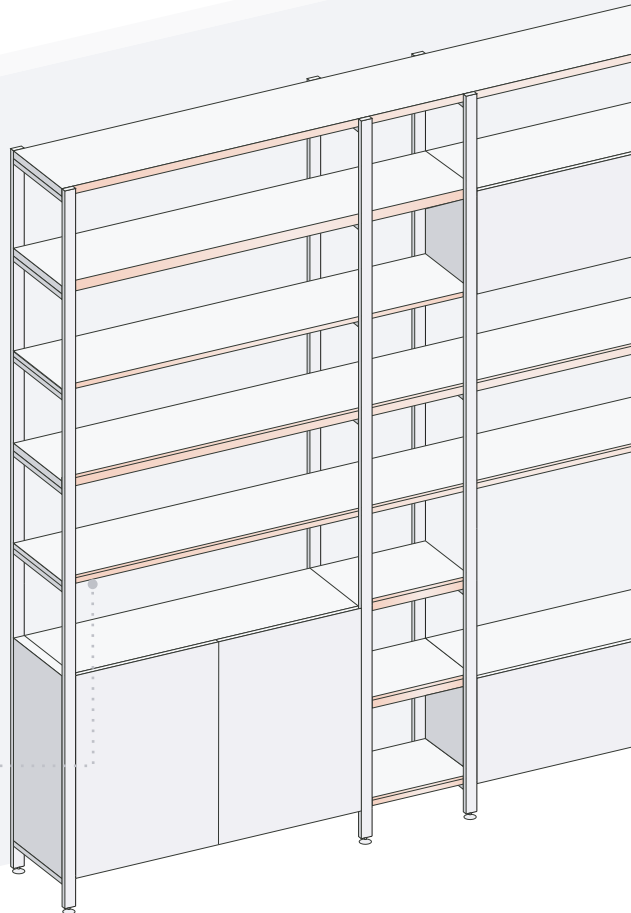
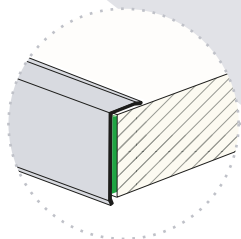

Modelli *Options*

misure in mm
dimensions in mm

CODICE
CODE

CODICE
CODE

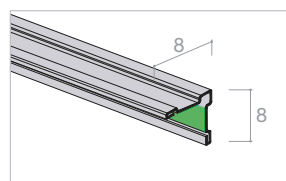

FBS 1336

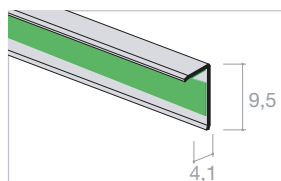

FBS 1341

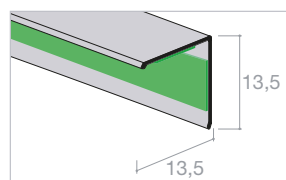

FBS 1337

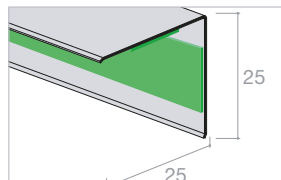

FBS 1342

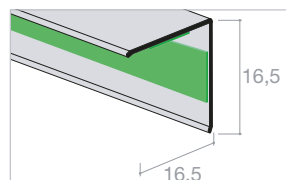

FBS 1338

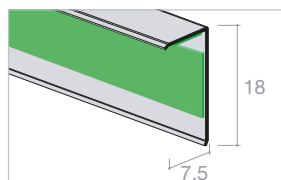

FBS 1343

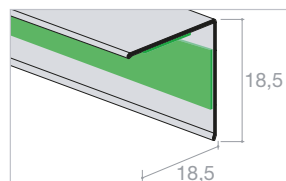

FBS 1339

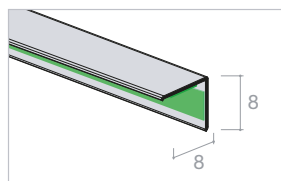

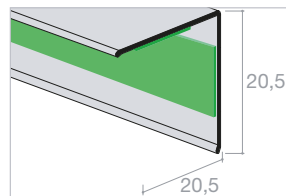

FBS 1344

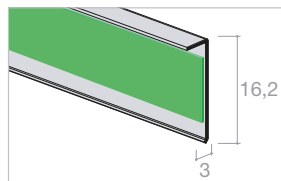

FBS 1340



FBS 1350

-  100% Alluminio
100% Aluminium
-  Biadesivo
Self-adhesive

PROFILI PER BORDATURA

BORDER PROFILES

Profili in alluminio per
bordatura vetri e pannelli
*Aluminium border profiles
for doors, cupboard doors
and glass partitions*

Lunghezza barre 3000 mm
Possibilità di fornire i profili
tagliati a misura
*Bar length 3000 mm
Cut to size profiles are available*

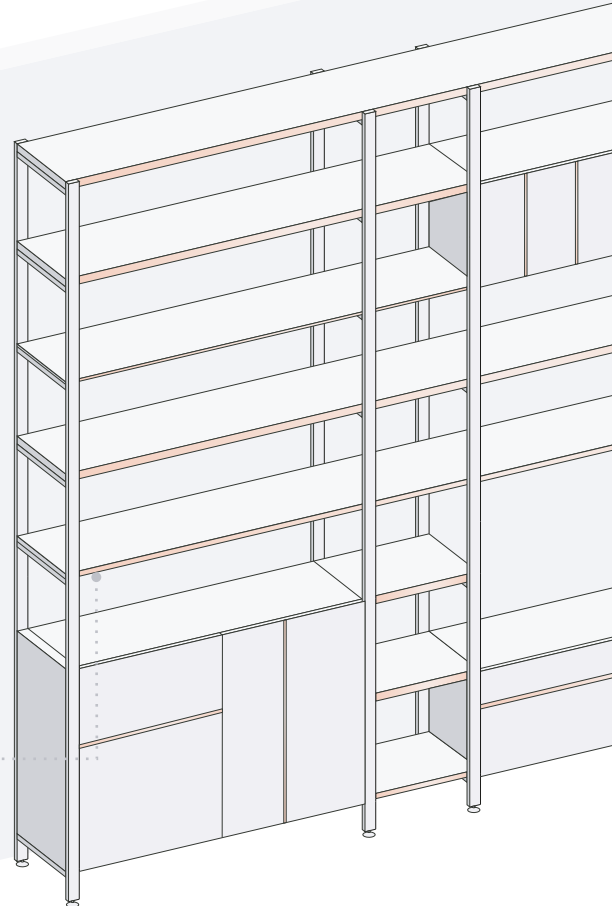
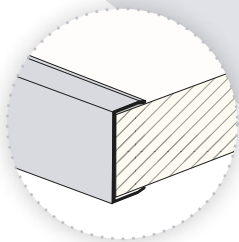

Modelli *Options*

misure in mm
dimensions in mm

CODICE
CODE

CODICE
CODE

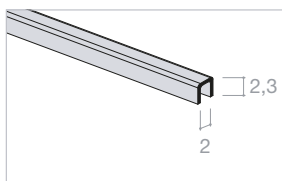

FBS 1002

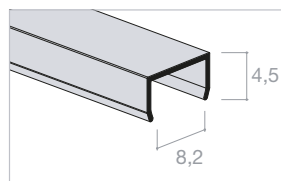

FBS 1008

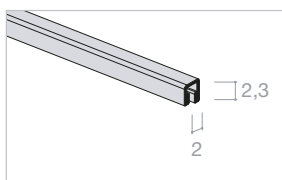

FBS 2052

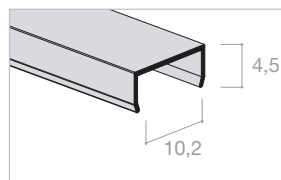

FBS 1010

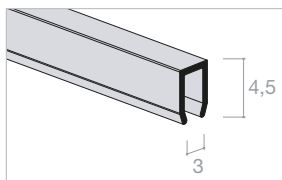

FBS 1003

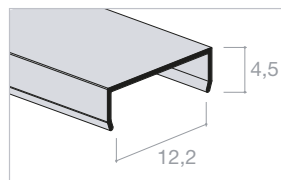

FBS 1012

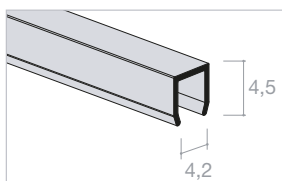

FBS 1004

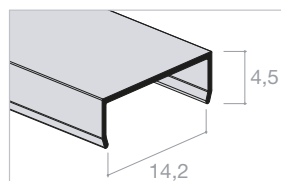

FBS 1014

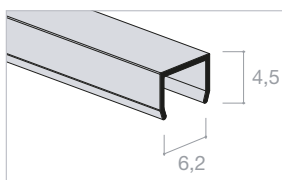

FBS 1006

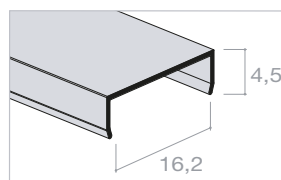

FBS 1016

PROFILI PER BORDATURA

BORDER PROFILES

Profili in alluminio per
bordatura vetri e pannelli
*Aluminium border profiles
for doors, cupboard doors
and glass partitions*

Lunghezza barre 3000 mm
Possibilità di fornire i profili
tagliati a misura
*Bar length 3000 mm
Cut to size profiles are available*

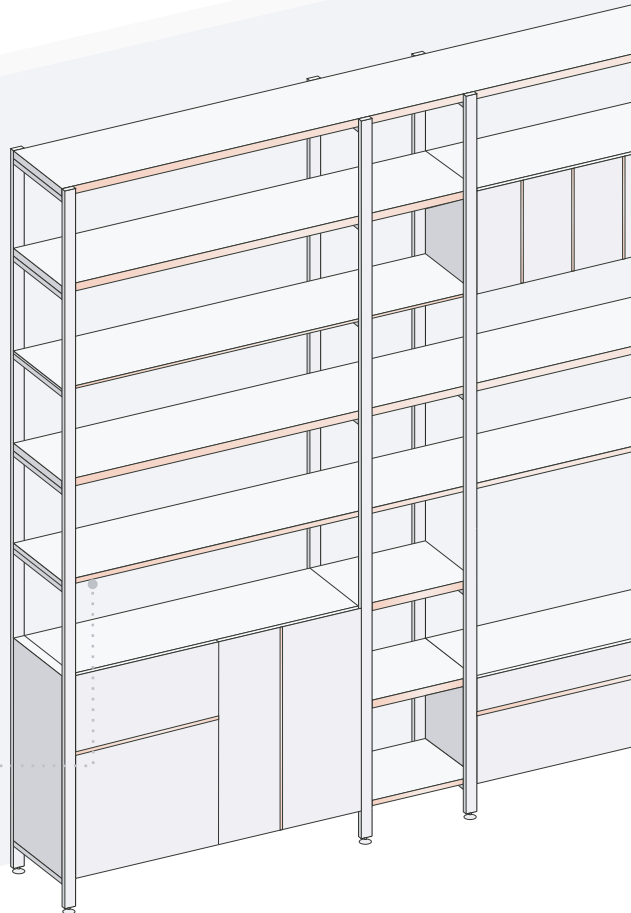
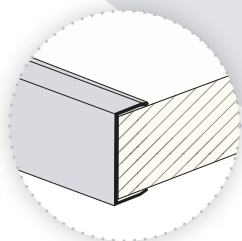

Modelli *Options*

misure in mm
dimensions in mm

CODICE
CODE

CODICE
CODE

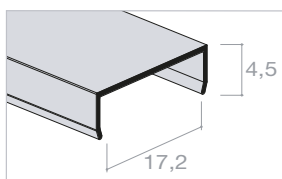

FBS 1017

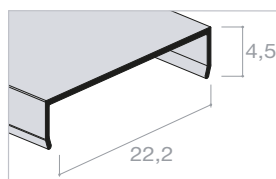

FBS 1022

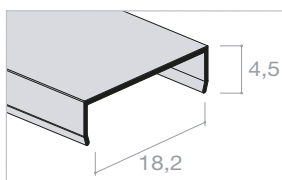

FBS 1018

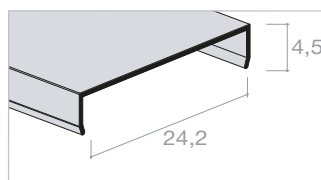

FBS 1024

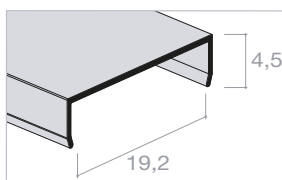

FBS 1019

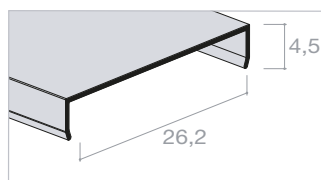

FBS 1026

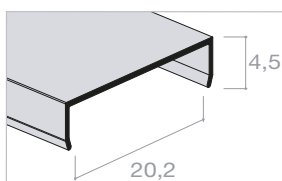

FBS 1020

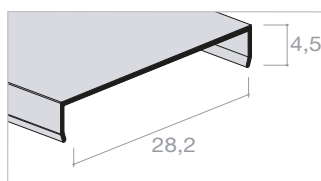

FBS 1028

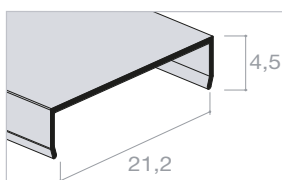

FBS 1021

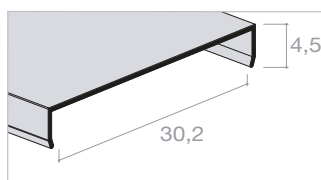

FBS 1030

PROFILI PER BORDATURA

BORDER PROFILES

Profili in alluminio per
bordatura vetri e pannelli
*Aluminium border profiles
for doors, cupboard doors
and glass partitions*

Lunghezza barre 3000 mm
Possibilità di fornire i profili
tagliati a misura
*Bar length 3000 mm
Cut to size profiles are available*

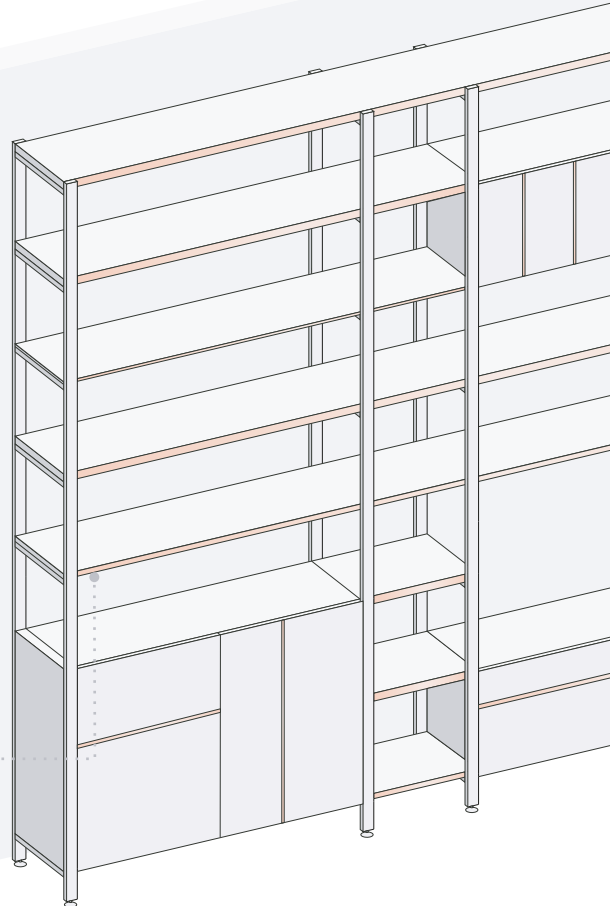
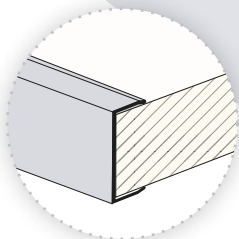

Modelli *Options*

misure in mm
dimensions in mm

CODICE
CODE

CODICE
CODE

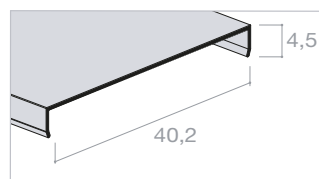

FBS 1040

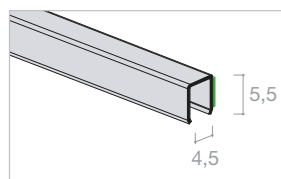

FBS 1404

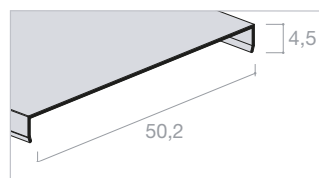

FBS 1050

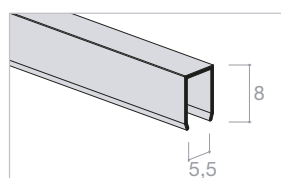

FBS 1205

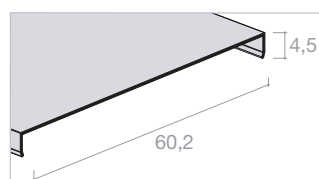

FBS 1060

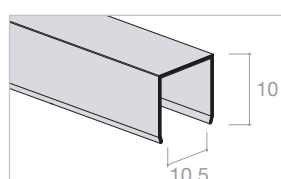

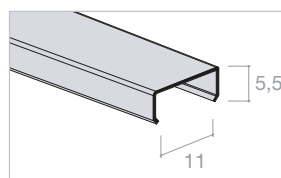

FBS 1210

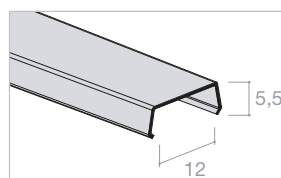

FBS 1211



FBS 1212

-  100% Alluminio
100% Aluminium
-  Biadesivo
Self-adhesive

PROFILI PER BORDATURA

BORDER PROFILES

Profili in alluminio per
bordatura vetri e pannelli
*Aluminium border profiles
for doors, cupboard doors
and glass partitions*

Lunghezza barre 3000 mm
Possibilità di fornire i profili
tagliati a misura
*Bar length 3000 mm
Cut to size profiles are available*

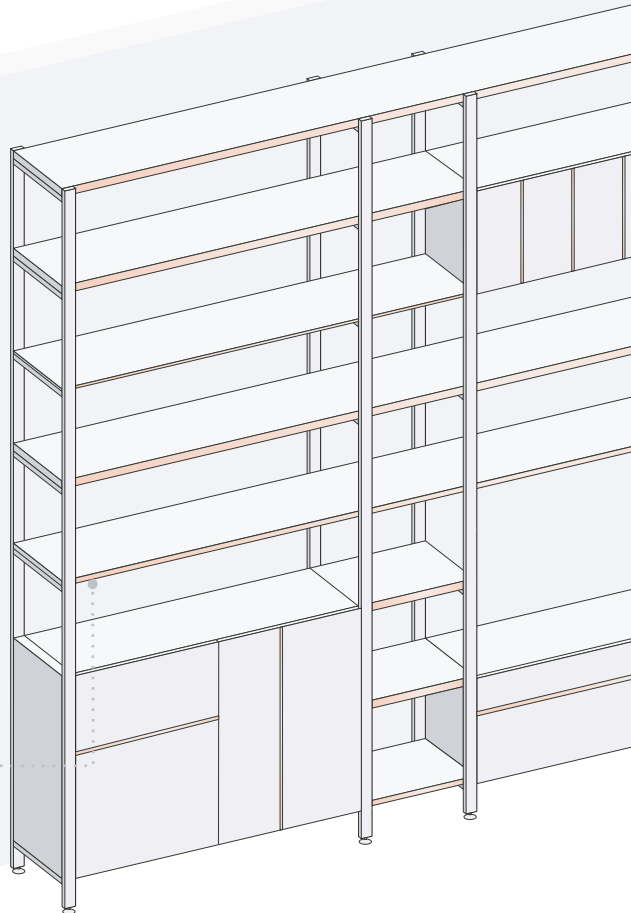
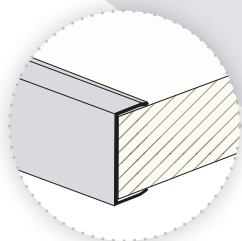

Modelli *Options*

misure in mm
dimensions in mm

CODICE
CODE

CODICE
CODE

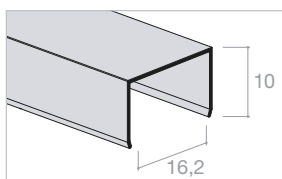

FBS 1216

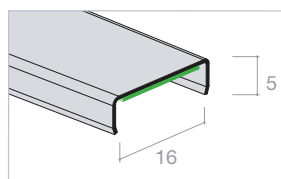

FBS 2021

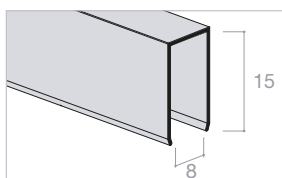

FBS 1208

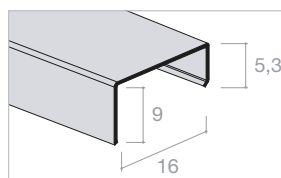

FBS 2022

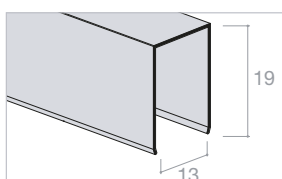

FBS 1215

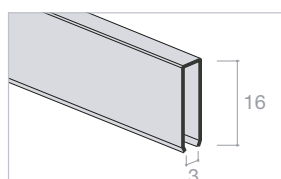

FBS 2023

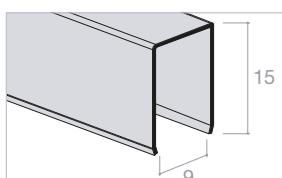

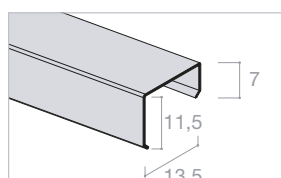

FBS 1218

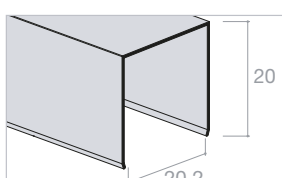

FBS 1220



FBS 1220

-  100% Alluminio
100% Aluminium
-  Biadesivo
Self-adhesive

PROFILI SPECIALI SPECIAL PROFILES

Profili di raccordo in alluminio
per pareti e pavimenti
*Aluminium junction profiles
for walls and floors*

Lunghezza barre 3000 mm
Possibilità di fornire i profili
tagliati a misura
*Bar length 3000 mm
Cut to size profiles are available*

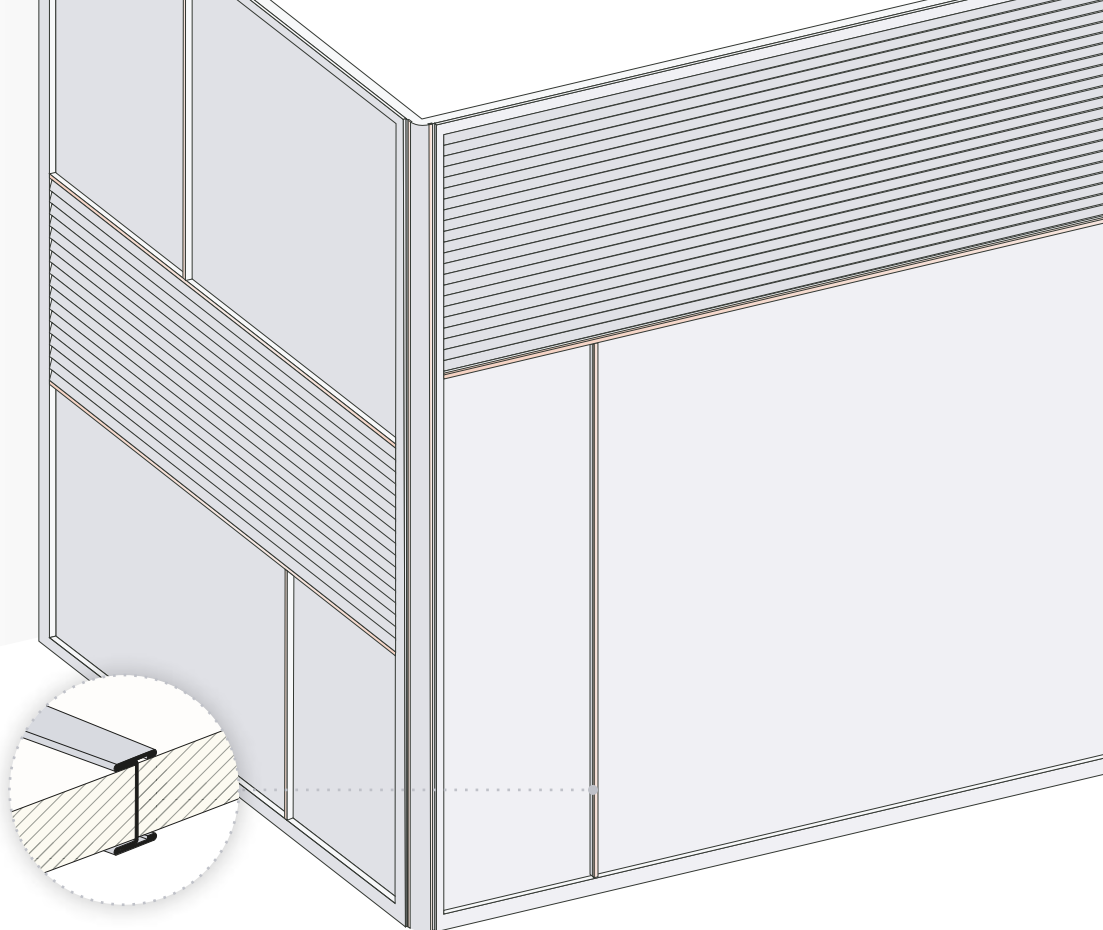

Modelli *Options*

misure in mm
dimensions in mm

CODICE
CODE

CODICE
CODE

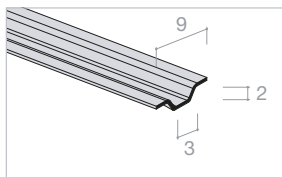

FBS 1501

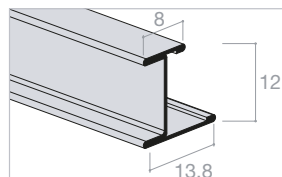

FBS 2017

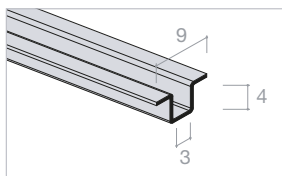

FBS 2019

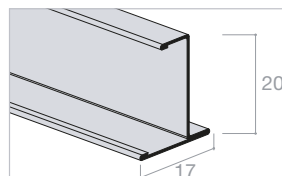

FBS 2018

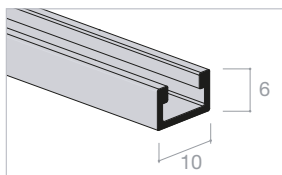

FBS 2015

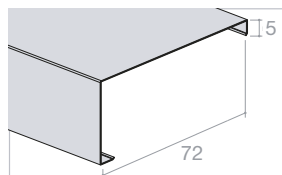

FBS 1345

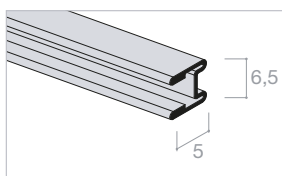

FBS 2061

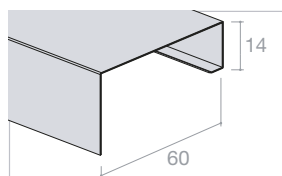

FBS 1346

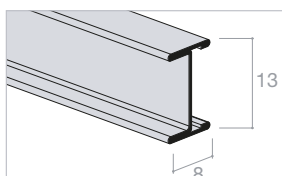

FBS 2016





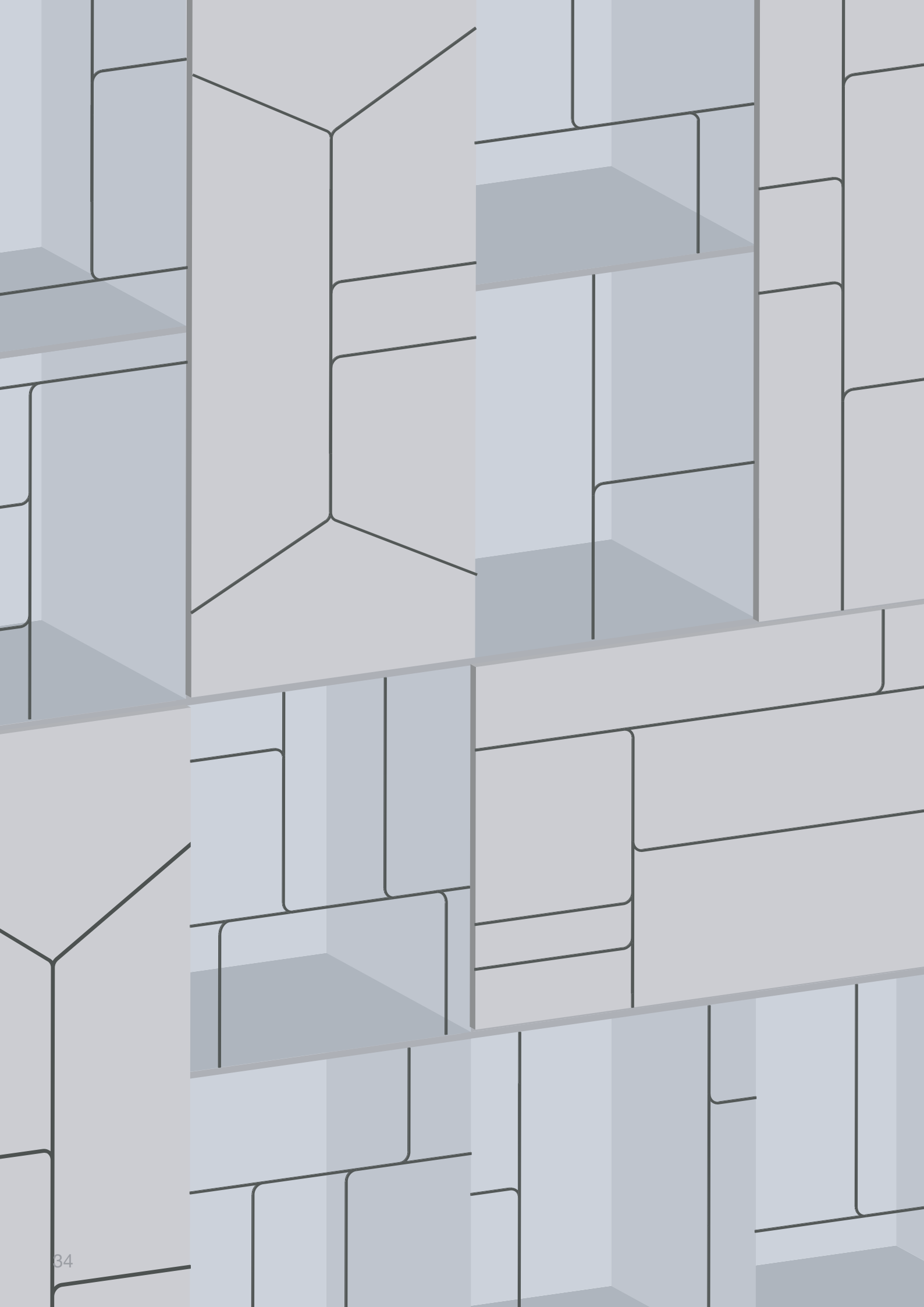

WAY design Gio Tiroto

Profili decorativi con biadesivo
per porte, sportelli e vetrate
*Decorative self-adhesive profiles
for doors, cupboard doors and
glass partitions*

Lunghezza barre 3000 mm
Possibilità di fornire i profili
tagliati a misura
*Bar length 3000 mm
Cut to size profiles are available*

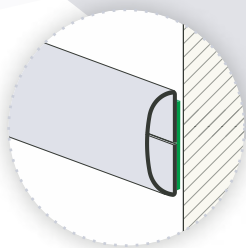

Modelli *Options*

misure in mm
dimensions in mm

CODICE
CODE

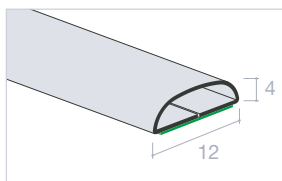

FBS 1324

- ABS riciclato e riciclabile
Recycled and recyclable
- 100% Alluminio
100% Aluminium



Accessori in ABS per FBS 1324 *ABS accessories for FBS 1324*

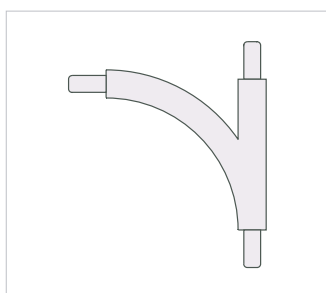

FBS 9549

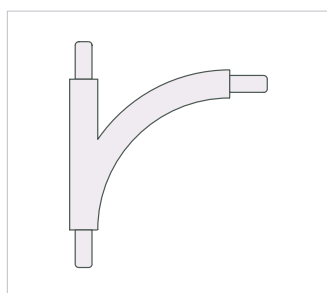

FBS 9550

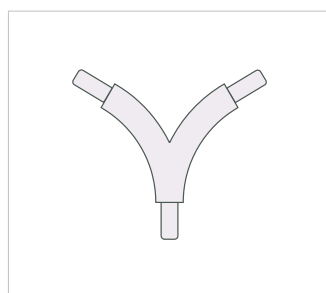

FBS 9551

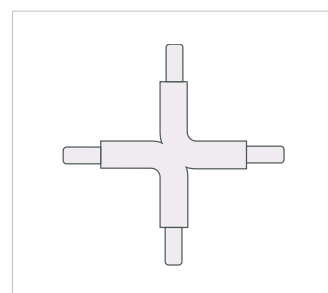

FBS 9552

FISSAGGIO *MOUNTING*

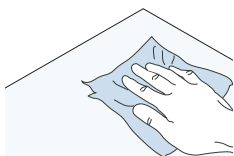

1. Pulire accuratamente
la superficie
*Thoroughly clean
the surface*

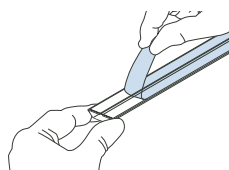

2. Rimuovere il film
del biadesivo
*Remove film from
the self-adhesive strip*

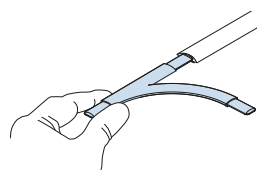

3. Inserire i giunti
Insert the joints

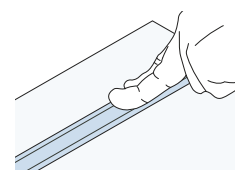

4. Incollare con una
leggera pressione il profilo
sulla superficie
*Stick the profile onto
the surface applying
a light pressure*





FERMAVETRI GLASS FIX

Profili decorativi fermavetro in alluminio con biadesivo

Aluminium self-adhesive glass-fix profiles

Profili fermavetro in polistirene con biadesivo

Polystyrene self-adhesive glass-fix profiles

Lunghezza barre 3000 mm

Possibilità di fornire i profili tagliati a misura

Bar length 3000 mm

Cut to size profiles are available

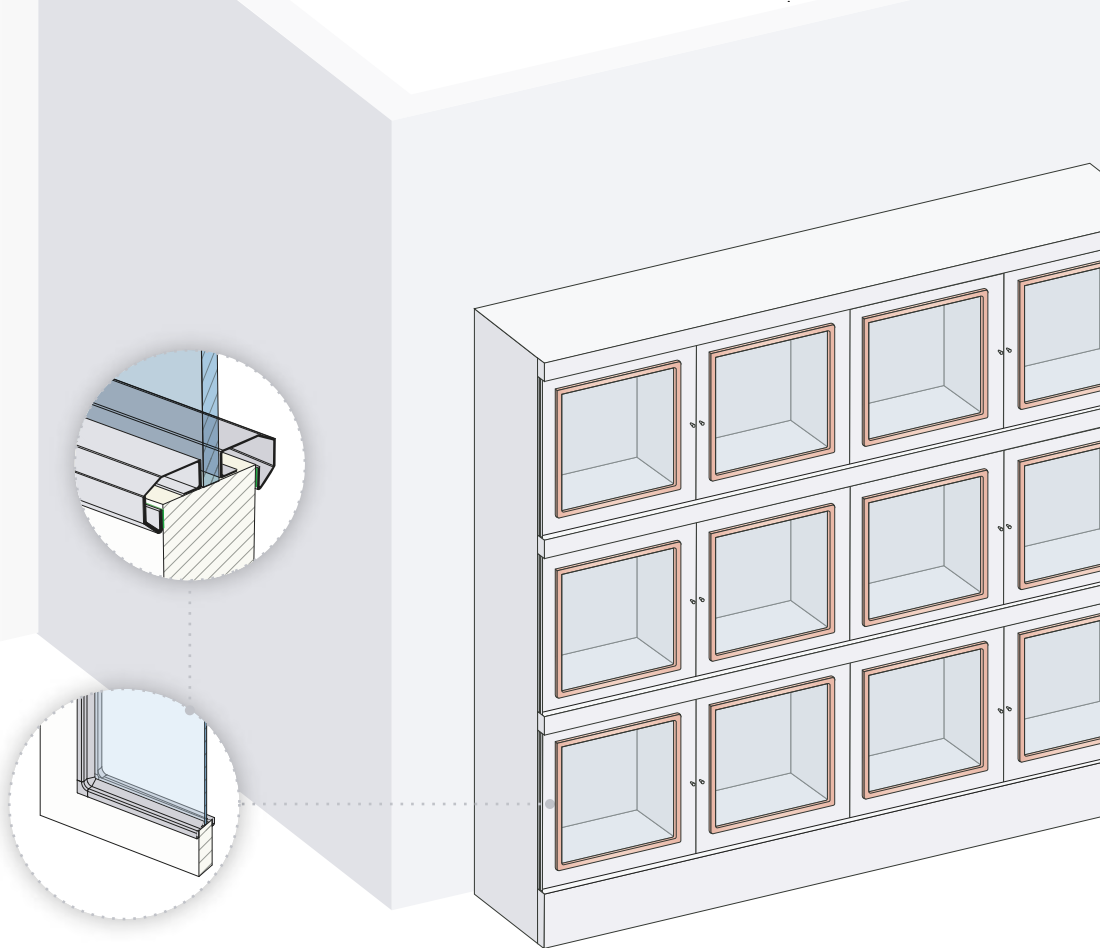



Modelli *Options*

misure in mm
dimensions in mm

CODICE
CODE

CODICE
CODE

-  Polistirene
Polystyrene
-  100% Alluminio
100% Aluminium
-  Biadesivo
Self-adhesive

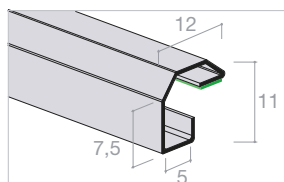

FBS 1236

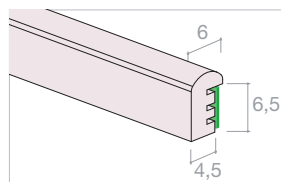
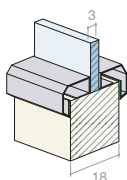

FBS 6204

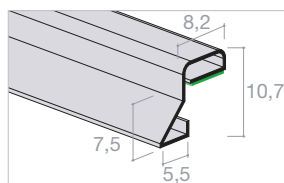
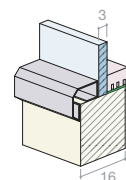

FBS 2077

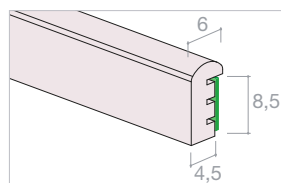
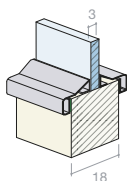

FBS 6205

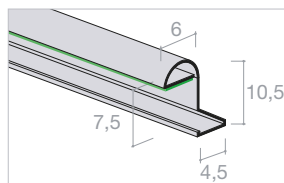
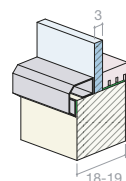

FBS 2055

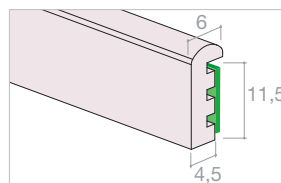
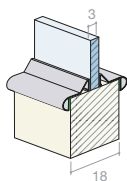

FBS 6206

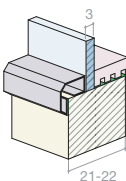

Angolari in ABS metallizzati *Metallic ABS corner*

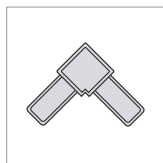

FBS 9075

per for FBS 1236

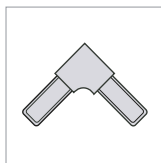

FBS 9077

per for FBS 2077

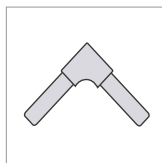

FBS 9455

per for FBS 2055

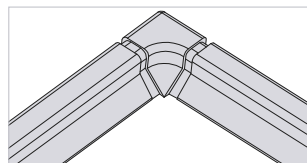

Angolo sagomato antideposito

Anti-dirt shaped corner

PROFILI AUTOADESIVI SELF-ADHESIVE PROFILES

Profili decorativi con
biadesivo per porte, sportelli
e vetrate

*Decorative self-adhesive
profiles for doors, cupboard
doors and glass partitions*

Lunghezza barre 3000 mm
Possibilità di fornire i profili
tagliati a misura
*Bar length 3000 mm
Cut to size profiles are available*

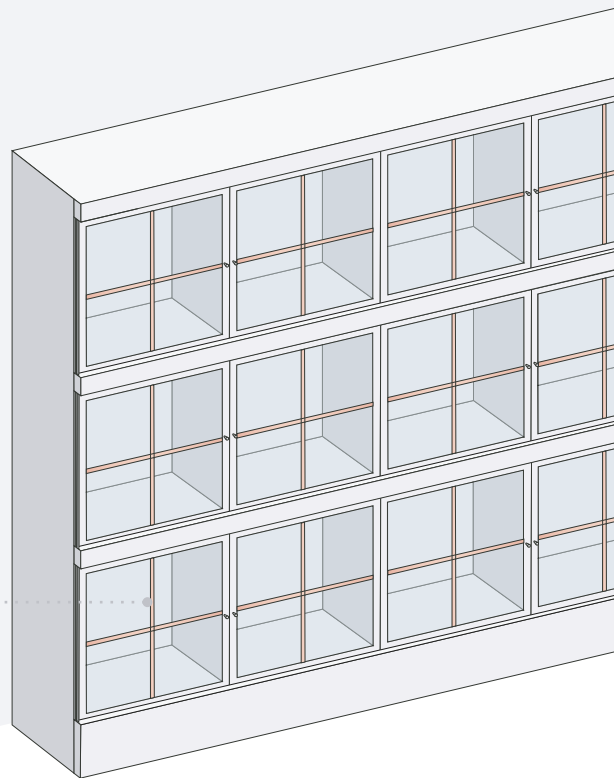
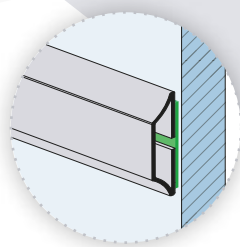

Modelli *Options*

misure in mm
dimensions in mm

CODICE
CODE

CODICE
CODE

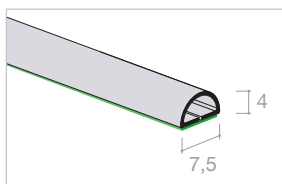

FBS 918

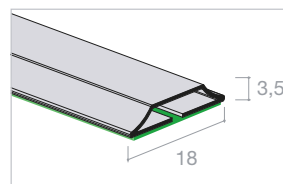

FBS 1193

- 100% Alluminio
100% Aluminium
- Biadesivo
Self-adhesive

Accessori in ABS metallizzati per FBS 918-D *Metallic ABS accessories for FBS 918-BD*

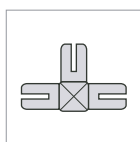

FBS 9052

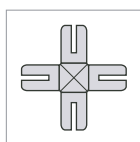

FBS 9053

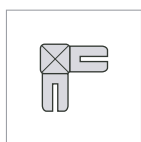

FBS 9055

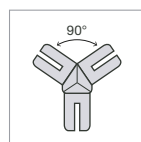

FBS 9056

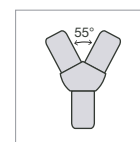

FBS 9057

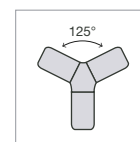

FBS 9058

Accessori in ABS metallizzati per FBS 1193 *Metallic ABS accessories for FBS 1193*

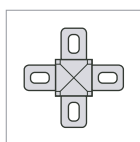

FBS 9193

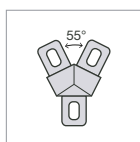

FBS 9194

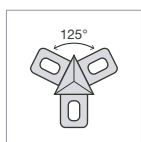

FBS 9195

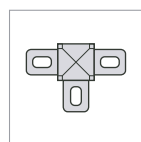

FBS 9196

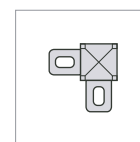

FBS 9197

FISSAGGIO *MOUNTING*

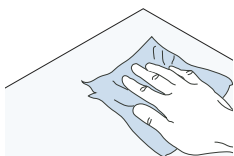

1. Pulire accuratamente
la superficie
*Thoroughly clean
the surface*

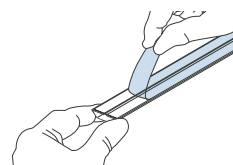

2. Rimuovere il film
del biadesivo
*Remove film from
the self-adhesive strip*

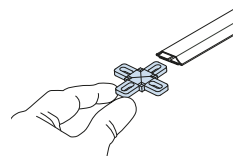

3. Inserire i giunti
Insert the joints

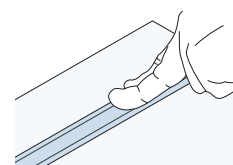

4. Incollare con una
leggera pressione il profilo
sulla superficie
*Stick the profile onto
the surface applying
a light pressure*

PROFILI PER CORNICI STRUCTURAL FRAMES

Specchiere con anima
in polistirene rivestita
di alluminio

*Mirrors with aluminium-coated
polystyrene core*

Lunghezza barre 3000 mm
Possibilità di fornire i profili
tagliati a misura

*Bar length 3000 mm
Cut to size profiles are available*

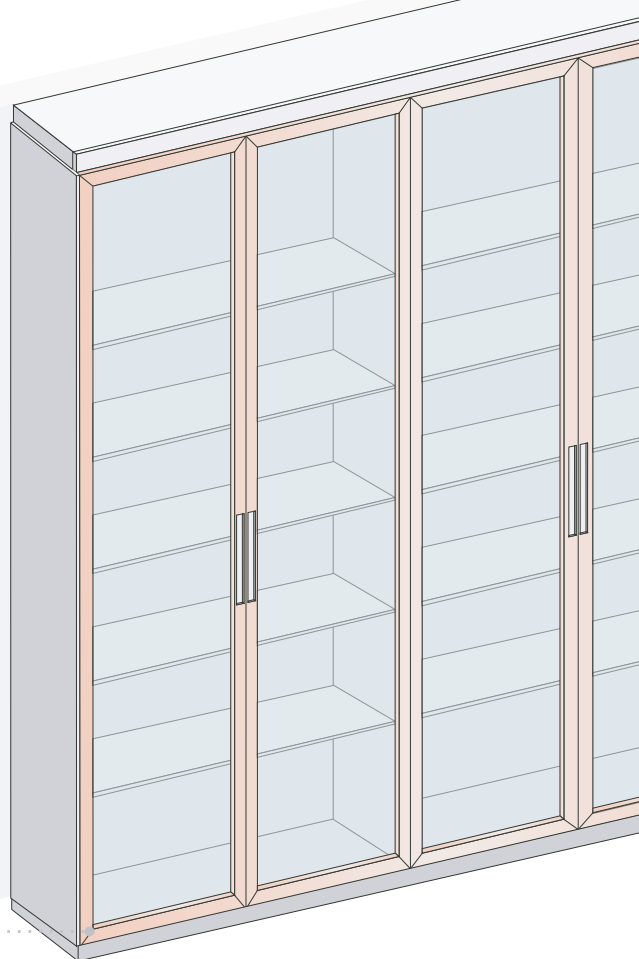
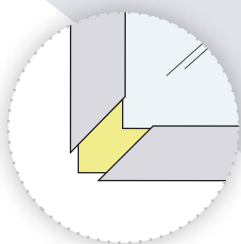

Modelli *Options*

misure in mm
dimensions in mm

CODICE
CODE

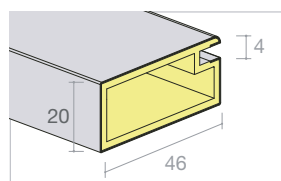

FBS 3046
Profilo perimetrale
Frame profile

- PVC
- 100% Alluminio
100% Aluminium

Accessori in ABS *ABS accessories*

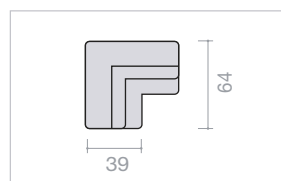

FBS 9446
per *for* FBS 3046
Angolo a scomparsa
Concealed corner

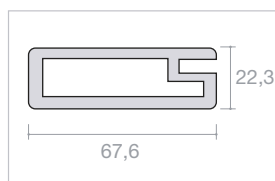

FBS 9447
per *for* FBS 3046
Flangia parasigoli
Safety flange

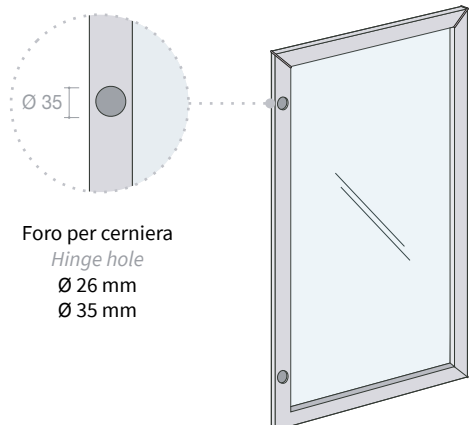

Foro per cerniera
Hinge hole
Ø 26 mm
Ø 35 mm

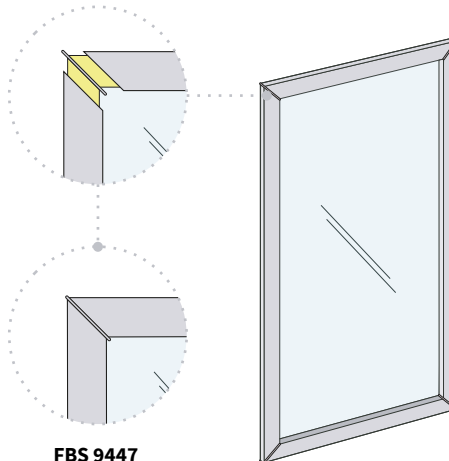

FBS 9447
Assemblaggio
con flangia
*Assembly with
flange*

PROFILI PER CORNICI

STRUCTURAL FRAMES

Specchiere con anima
in polistirene rivestita
di alluminio

*Mirrors with aluminium-coated
polystyrene core*

Lunghezza barre 3000 mm
Possibilità di fornire i profili
tagliati a misura

*Bar length 3000 mm
Cut to size profiles are available*

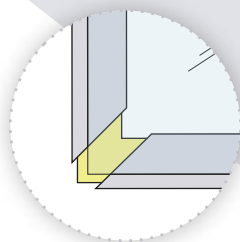

ASSEMBLAGGIO STANDARD
STANDARD ASSEMBLY

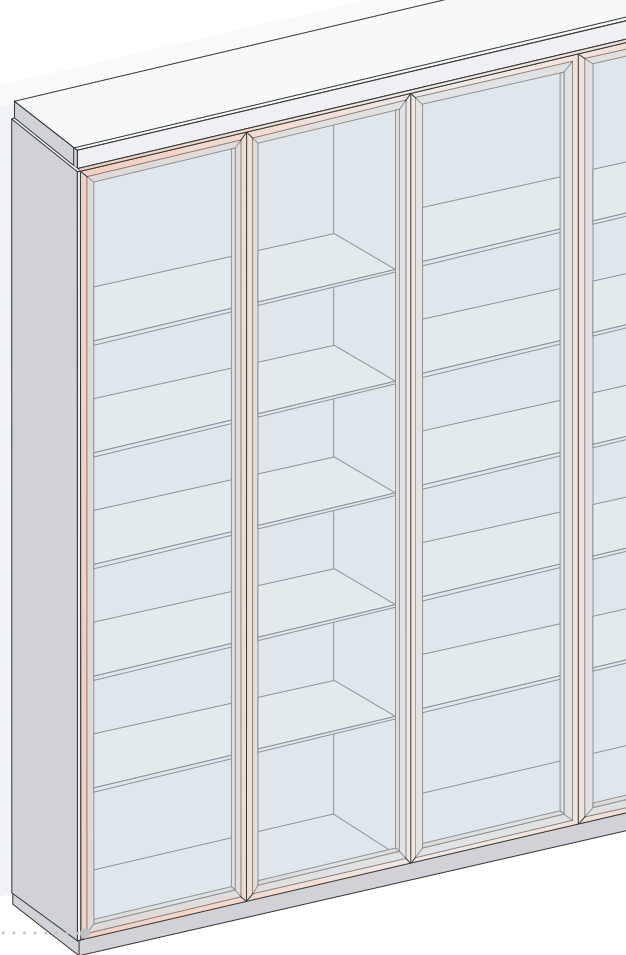

Modelli Options

misure in mm
dimensions in mm

CODICE
CODE

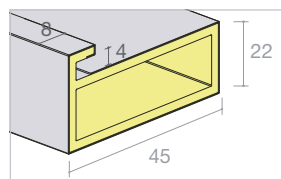

FBS 3045
Profilo perimetrale
Frame profile

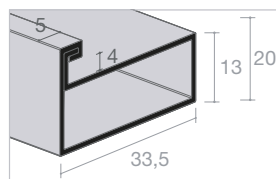

FBS 2133
SAT-NAT

- PVC
- 100% Alluminio
100% Aluminium

Accessori in ABS ABS accessories

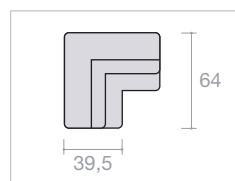

FBS 9445
per for FBS 3045
Angolo a scomparsa
Concealed corner

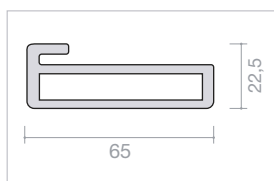

FBS 9444
per for FBS 3045
Flangia paraspigoli
Safety flange

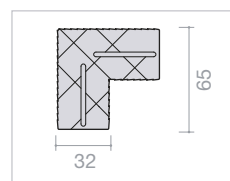

FBS 9433
per for FBS 2133
Angolo a scomparsa
Concealed corner

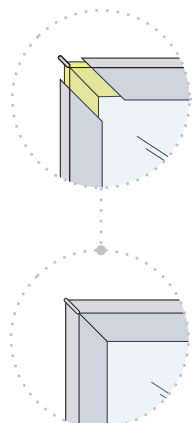

FBS 9444
Assemblaggio
con flangia
*Assembly with
flange*

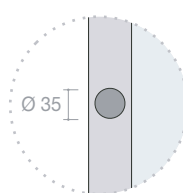
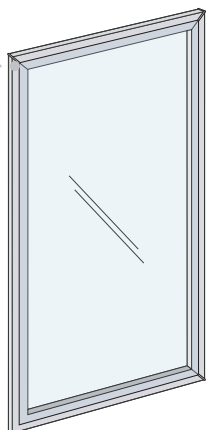

Foro per cerniera
Hinge hole
Ø 26 mm
Ø 35 mm

Foro per cerniera
Hinge hole
per for FBS 2133
Ø 26 mm

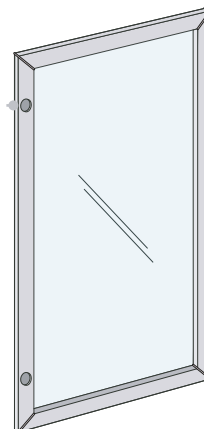

PROFILO PER RIPIANO PORTAVALIGIE *PROFILE FOR LUGGAGE RACK*

Profili in alluminio estruso
Extruded aluminium profiles

Finiture disponibili
Available finishing

ANODIZZATI
ANODIZED



SN - sat nat



D - chrome



D6 - brass gold

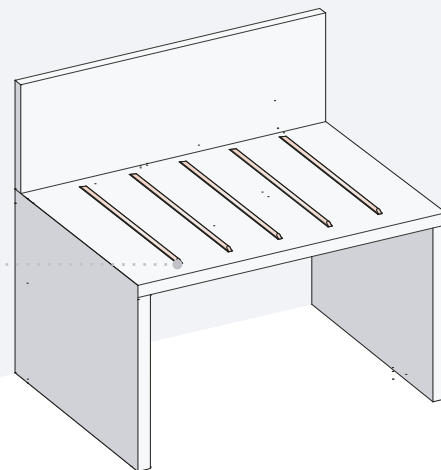
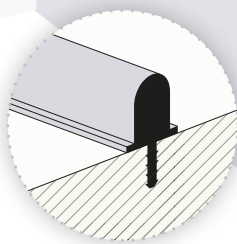

Modelli *Options*

misure in mm
dimensions in mm

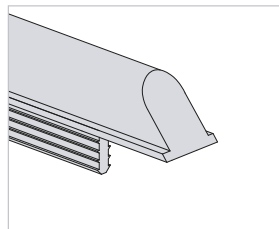
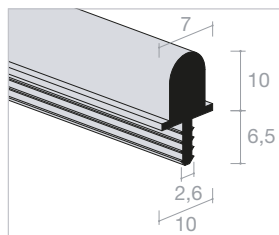

CODICE
CODE

FBS 7110

FBS 7110
Taglio a 45°
45° Cutting

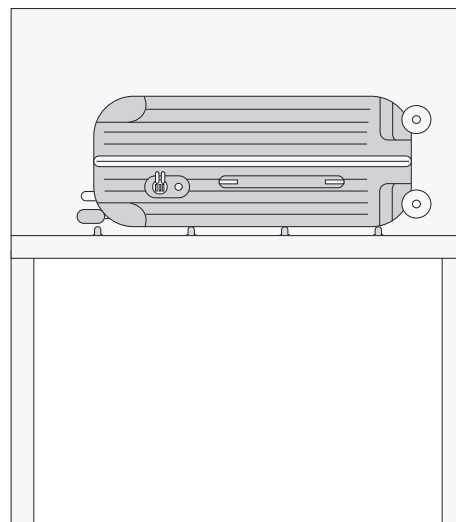

PROFILO PORTA POSTER POSTER HANGING PROFILE

Profilo in alluminio piegato a freddo
Roll-formed aluminium profile

Il profilo è stato progettato per i più comuni formati di poster
The profile is designed for the most common poster formats

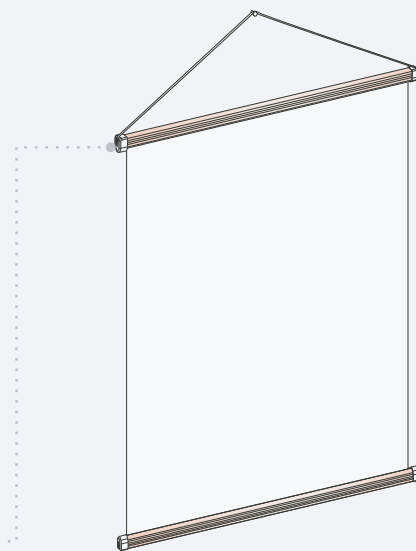
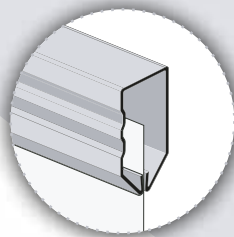
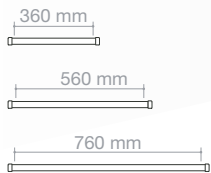

misure in mm
dimensions in mm

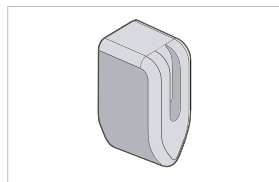
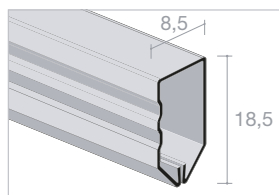

CODICE
CODE

FBS 200

FBS 9400

● U9 - anthracite

Lato con due scanalature
Side with two grooves

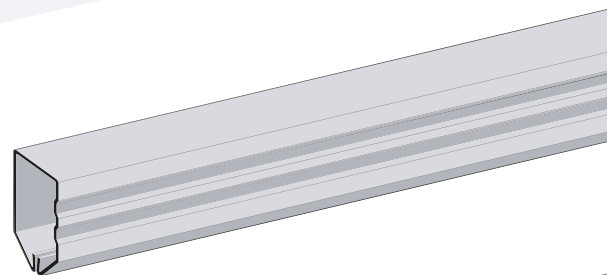

Lato piano
Plain side

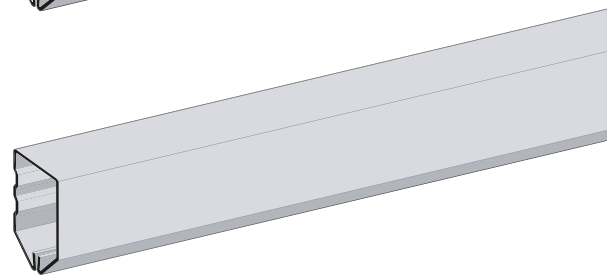

ISTRUZIONI DI MONTAGGIO *MOUNTING INSTRUCTIONS*

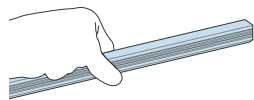

1. Prendere il profilo
Take the profile

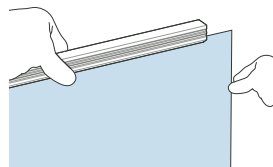

2. Inserire il poster all'interno dell'apposita fessura
Insert the sheet inside the slot

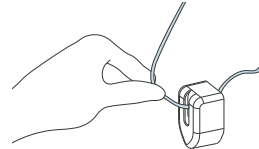

3. Inserire il filo nell'apposito foro dei due tappi superiori
Insert the thread into the designated hole in the two upper end caps

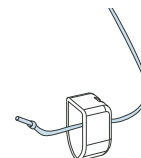

4. Realizzare un nodo all'estremità del filo
Make a knot at the end of the thread

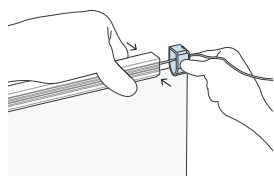

5. Inserire il profilo superiore nei due tappi, esercitando una leggera pressione
Insert the upper profile in the two end caps, applying a light pressure

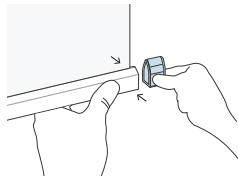

6. Inserire il profilo inferiore nei due tappi, esercitando una leggera pressione
Insert the lower profile in the two end caps, applying a light pressure

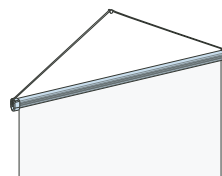

7. Appendere il poster
Hang the poster

FINITURE FINISHING

ANODIZZATI ANODIZED

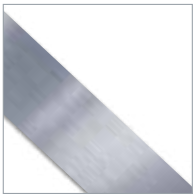

A - brushed

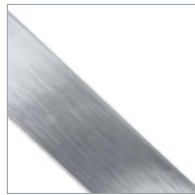

A2 - inox brushed



B - mill finish



B2 - mill inox



SN - sat nat

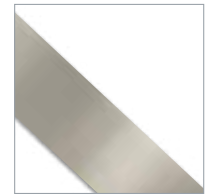

BR2 - matt bronze

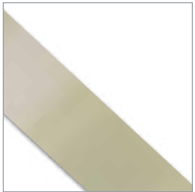

B3 - mill gold



RA - copper

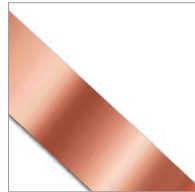

RA2 - polished copper



D - chrome



D2 - polished gold



D6 - brass gold

PREVERNICIATI PREPAINTED

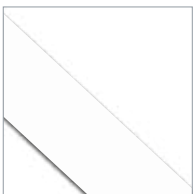

M3 - polished white



M4 - matt white



U6 - inox



U8 - brushed bronze



U5 - alumatt

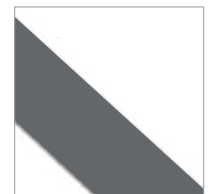

U9 - anthracite



U7 - olive green



L1 - polished black

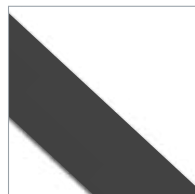

L2 - matt black

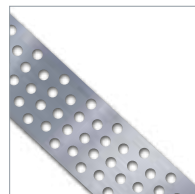

WIND
Disponibile per tutte
le finiture
Available for
all finishing

Tutti i profili sono forniti di film protettivo
All profiles are supplied with a protective film

Specifiche

ALLUMINIO MICROFORATO

Con aperture rotonde e sfalsate, il metallo perforato è un materiale industriale utilizzato in numerosi progetti di interni.

Con la sua trasparenza, il materiale funziona bene con altri elementi e aiuta a creare profondità. È apprezzato soprattutto per la sua qualità grafica e l'effetto ottico che produce quando viene stratificato.

Technical details

MICRO-PERFORATED ALUMINIUM

With round and staggered openings, perforated metal is an industrial material that is used in a number of interior projects.

With its transparency, the material works well with other elements and helps create depth. It is mostly appreciated for its graphic quality and the optical effect it produces when layered.

TRONCATORI

CUTTING MACHINES

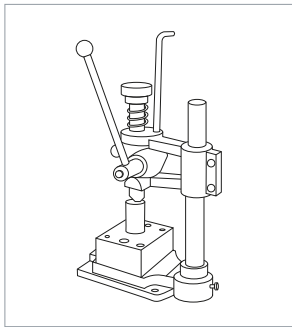

FBS 7700

Troncatore manuale per bandelle
Manual cutting machine for strips

Comprensivo di uno stampo a scelta tra
Including a mould to choose from:

FBS 7701 (per troncatura profilo *for cutting profile* FBS 8006 e 2106 90° / R3)

FBS 7704 (per troncatura profilo *for cutting profile* FBS 8008 90° / R4)

FBS 7702 (per troncatura profilo *for cutting profile* FBS 8010 90° / R5)

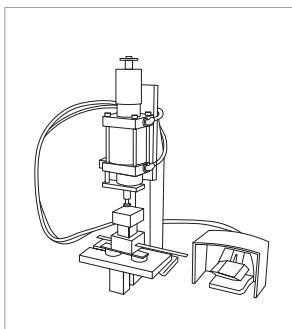

FBS 7800

Troncatore pneumatico a un pistone per bandelle
One-piston pneumatic cutting machine for strips

Comprensivo di uno stampo a scelta tra
Including a mould to choose from:

FBS 7701 (per troncatura profilo *for cutting profile* FBS 8006 e 2106 90° / R3)

FBS 7704 (per troncatura profilo *for cutting profile* FBS 8008 90° / R4)

FBS 7702 (per troncatura profilo *for cutting profile* FBS 8010 90° / R5)

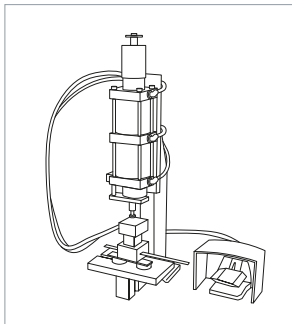

FBS 7801

Troncatore pneumatico a due pistoni per bandelle e profili estrusi
Two-piston pneumatic cutting machine for strips and extruded profiles

Comprensivo di uno stampo a scelta tra
Including a mould to choose from:

FBS 7701 (per troncatura profilo *for cutting profile* FBS 8006 e FBS 2106, FBS 7106 90° / R3)

FBS 7704 (per troncatura profilo *for cutting profile* FBS 8008 90° / R4)

FBS 7702 (per troncatura profilo *for cutting profile* FBS 8010, FBS 2110 90° / R5)

Stampi per *moulds for* FBS 8006, FBS 8008, FBS 8010, FBS 2106, FBS 7106

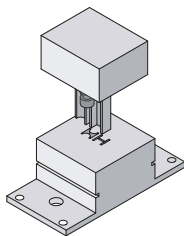

FBS 7701
R3 - 90°

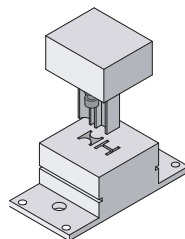

FBS 7704
R4 - 90°

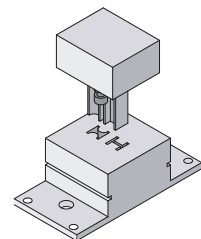

FBS 7702
R5 - 90°

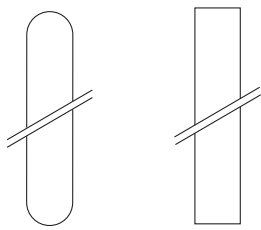

Raggio a 3 mm
3 mm radius

Taglio a 90°
90° cut

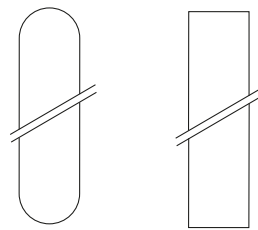

Raggio a 4 mm
4 mm radius

Taglio a 90°
90° cut

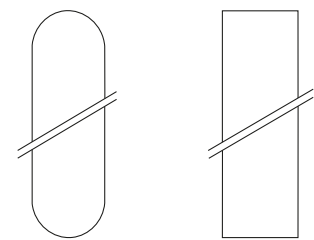

Raggio a 5 mm
5 mm radius

Taglio a 90°
90° cut

SCOPRI TUTTI I NOSTRI PRODOTTI SU
DISCOVER OUR FULL PRODUCT RANGE AT

fbsprofilati.it

COPYRIGHT 2023
FBSProfilati srl

Edizione 2023



Il presente catalogo è di proprietà
di FBSProfilati S.r.l. Tutti i diritti riservati.
Sono vietate riproduzione e alterazione.
Illustrazioni e dati contenuti in questo catalogo
hanno valore indicativo.
Per una corretta installazione
fare riferimento ai manuali.

This catalogue is property of FBSProfilati S.r.l.

All rights reserved.

Reproduction and Alterations are forbidden.

*All illustrations and information in this
catalogue are indicative.*

*For a correct installation please refer
to the assembly instruction manuals.*

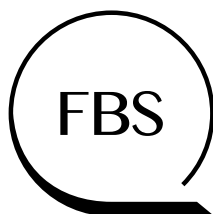

PROFILATI ITALIANI

FBSProfilati srl

Via Edison, 251
20019 Settimo Milanese MI - Italia

phone: +39 024564768 | + 39 0248916411

info@fbsprofilati.it
fbsprofilati.it