

**ALUMIX** *Decorative profiles*



**FBS Profilati srl, fondata nel 1999 dalla seconda generazione imprenditoriale della nostra famiglia, è un'azienda dinamica che trae la sua essenza dal concept del "MADE IN ITALY" tramandato attraverso l'esperienza delle sue figure storiche che dal 1964 si dedicano con entusiasmo alla progettazione e produzione di profili decorativi in alluminio e serrandine. Nella nostra sede di Settimo Milanese, che si sviluppa su una superficie complessiva di 5000 m<sup>2</sup>, creiamo prodotti sempre all'avanguardia e al passo con le più moderne tendenze del mondo del design per arredamento di interni a partire da materie prime di qualità eccellente.**

FBS Profilati srl, founded in 1999 by the second managerial generation of our family, is a dynamic company that draws its essence from the concept of "MADE IN ITALY" handed down through the experience of senior figures who have enthusiastically committed to designing and manufacturing aluminium decorative profiles and tambour doors since 1964.

In our headquarters in Settimo Milanese, stretching over a 5000m<sup>2</sup> area, we create forefront and contemporary up-to-date products with modern furniture design trends, exclusively using excellent raw materials.



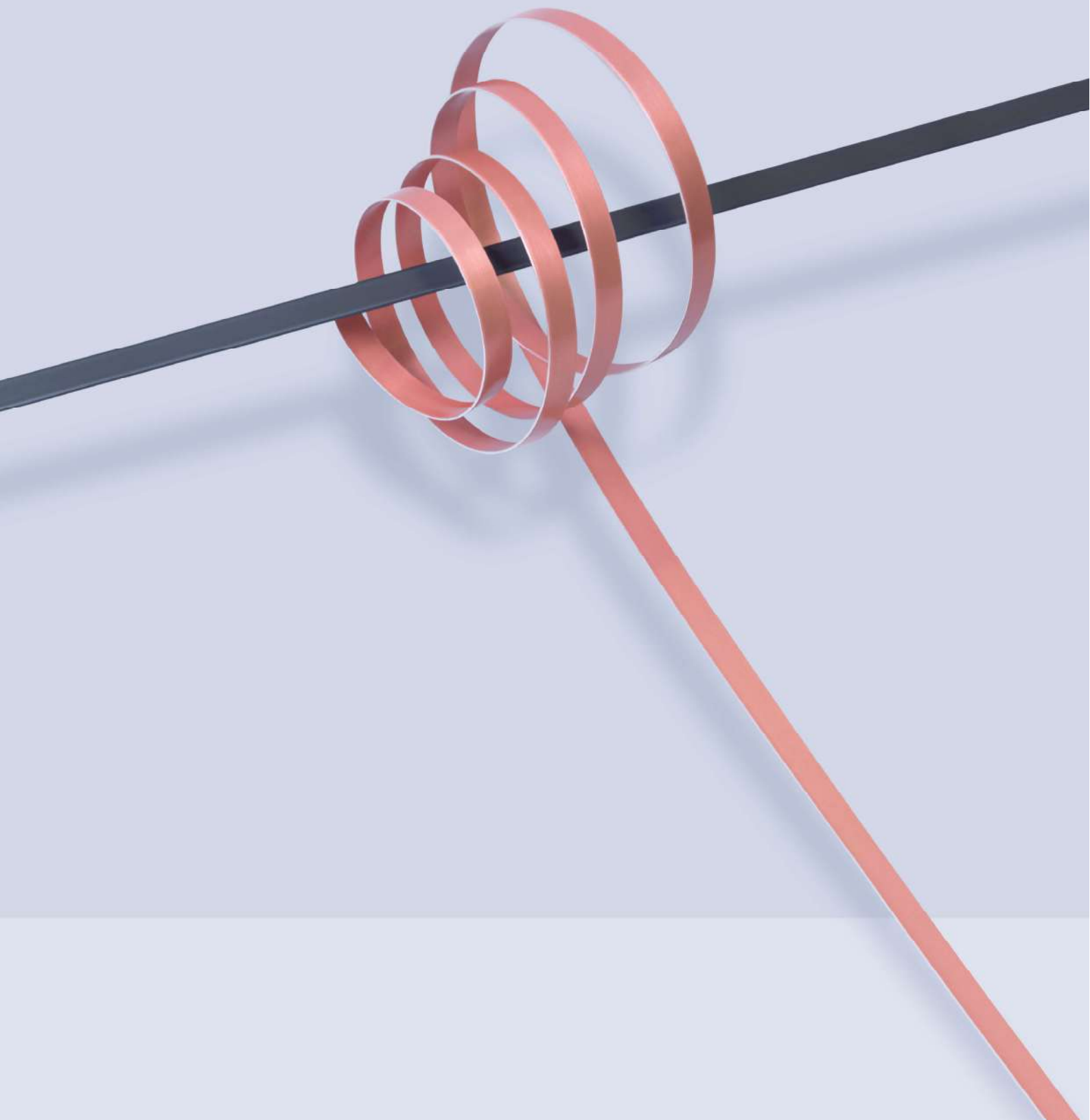

# ALUMIX

Un'ampia gamma di profili decorativi in alluminio per l'industria dell'arredo. FBS Profilati srl produce e fornisce profili in alluminio standard e speciali da catalogo, oppure personalizzati su disegno e specifiche del cliente, anche con caratteristiche tecniche e dimensionali molto elevate.

I profili in alluminio piegati a freddo prodotti da FBS Profili srl sono forniti in più di 20 diverse finiture. Quest'ultime si raggruppano essenzialmente in due macro categorie: le finiture di anodizzazione e quelle di verniciatura. Durante il processo di produzione, la scelta della profilatura a freddo ha permesso di contenere al minimo l'impatto ambientale poiché il materiale viene lavorato a temperatura ambiente senza la necessità di macchinari aggiuntivi.

*A wide range of standard and tailor made decorative aluminium profiles for the design industry. FBS Profilati produces and supplies standard and special aluminum profiles, from stock items to completely customized ones according to the customer's design and specifications, even with particularly high technical and size characteristics.*

*The roll formed aluminium profiles produced by FBS Profilati are supplied in more than 20 different finishes which are divided in two macro categories: anodized or pre-painted. During the production process, the choice of environmentally friendly roll forming technology has made it possible to keep the environmental impact to the minimum, since the material is formed in cold conditions without the need for extra tooling.*

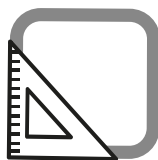

**lavorazioni su misura**  
*custom made products*



**profilatura a freddo**  
*roll formed profiling*



**progettazione  
di nuovi prodotti**  
*development of  
new products*



**materiali riciclabili**  
*recyclable materials*

## **Profili decorativi** *Decorative profiles*

---

<b>ESTRUSI</b> <i>EXTRUSIONS</i>	pag. 9
<b>PROFILATI A FREDDO</b> <i>ROLL-FORMED PROFILES</i>	pag. 11
<b>BANDELLE</b> <i>STRIPS</i>	pag. 13
<b>PROFILI AUTOADESIVI PER VETRO</b> <i>SELF-ADHESIVE PROFILES FOR GLASS</i>	pag. 17
<b>POFILI A T</b> <i>T-PROFILES</i>	pag. 23
<b>PROFILI PER BORDATURA</b> <i>BORDER PROFILES</i>	pag. 26
<b>PROFILI DI RACCORDO</b> <i>CONNECTING PROFILES</i>	pag. 31
<b>FERMAVETRI</b> <i>GLASS FIX</i>	pag. 34
<b>PROFILI AUTOADESIVI</b> <i>SELF-ADHESIVE PROFILES</i>	pag. 35
<b>PROFILI PER CORNICI</b> <i>FRAMES</i>	pag. 36
<b>PROFILO PER RIPIANO PORTAVALIGIE</b> <i>PROFILES FOR LUGGAGE RACK</i>	pag. 38
<b>PROFILO PORTA POSTER</b> <i>POSTER HANGING PROFILE</i>	pag. 39

## **Finiture e specifiche tecniche** *Finishes and technical details*

---

## **Troncatori** *Cutting machines*

---

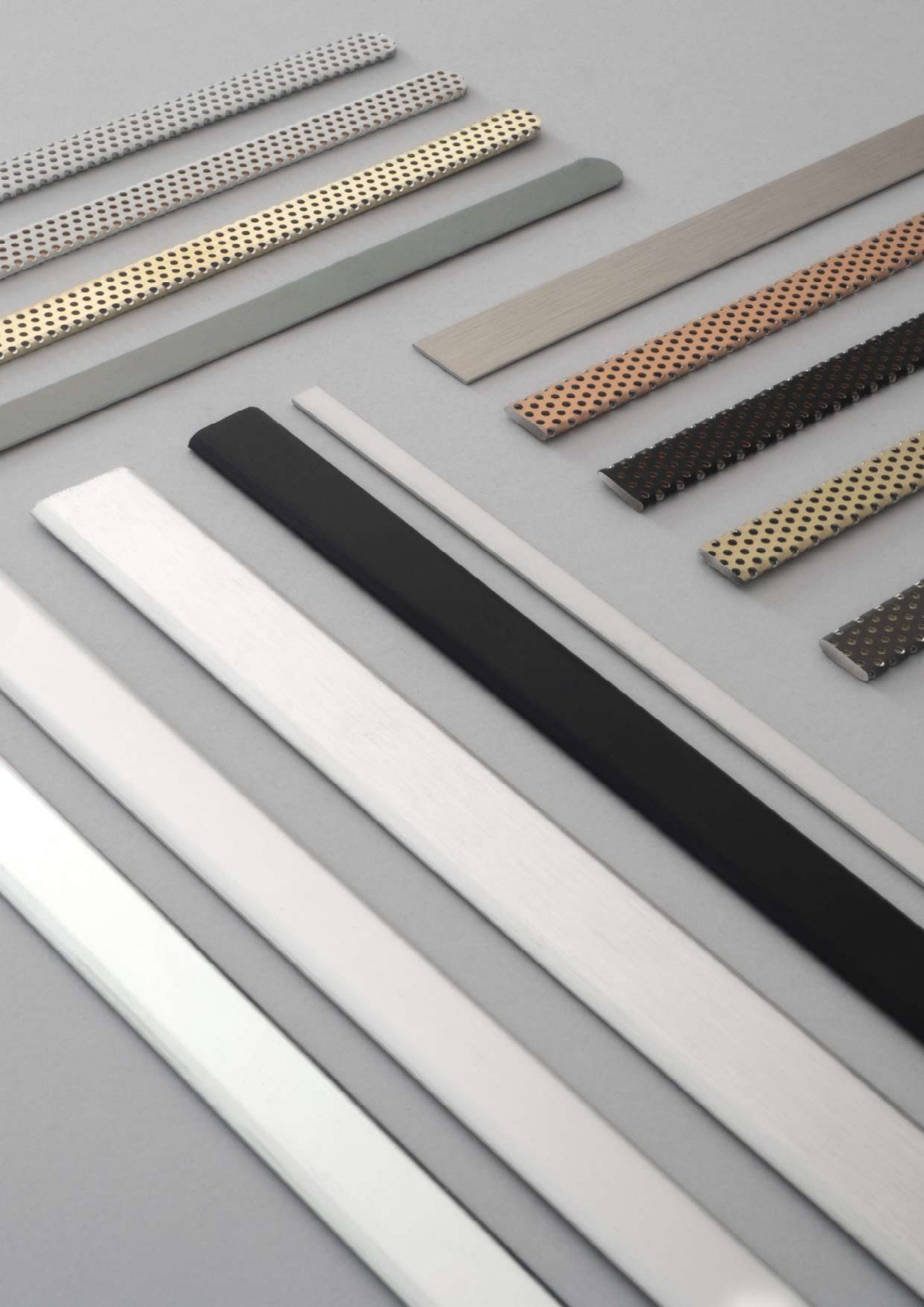

# PROFILI DECORATIVI PER PORTE

## DECORATIVE INSERTS FOR DOORS

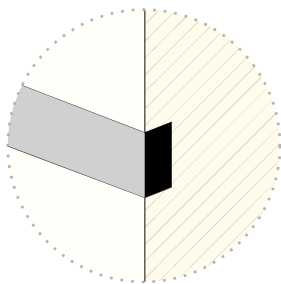

**ESTRUSI**  
EXTRUSIONS

Tipologia di fissaggio ad incasso  
Fixing procedure: inset

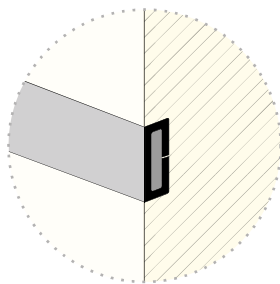

**PROFILATI A FREDDO**  
ROLL-FORMED PROFILES

Tipologia di fissaggio ad incasso  
Fixing procedure: inset

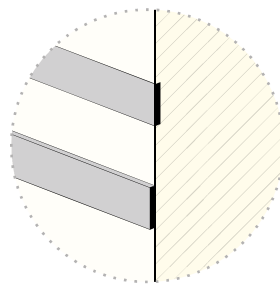

**BANDELLE**  
STRIPS

Tipologia di fissaggio ad incasso o esterno  
Fixing procedure: inset or surface mounted

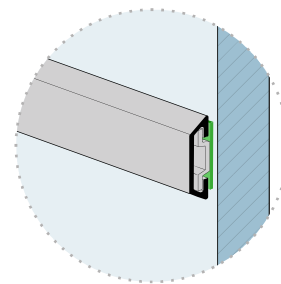

**PROFILATI DECORATIVI**  
DECORATIVE PROFILES

Tipologia di fissaggio ad incasso o esterno  
Fixing procedure: inset or surface mounted

### Prezzo Price



### Tenuta Hold



### Finiture Finishes

#### ANODIZZATI ANODIZED

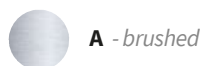

**A** - brushed



**B3** - mill gold



**A2** - inox brushed



**RA** - matt copper



**B** - mill finish



**R2** - polished copper



**B2** - mill inox



**D** - chrome



**SN** - sat nat



**D6** - brass gold



**BR2** - matt bronze



**D2** - polished gold

#### PREVERNICIATI PREPAINTED



**M3** - polished white



**L1** - polished black



**U9** - anthracite



**L2** - matt black



**U5** - alumatt

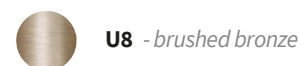

**U8** - brushed bronze



**U6** - inox



**M4** - matt white





45



## ESTRUSI EXTRUSIONS

Profili in alluminio estruso  
da incasso per porte,  
boiserie e mobili

*Extruded inset aluminium  
profile for doors, boiserie  
and furniture*

**Colori disponibili**  
*Available colours*

**ANODIZZATI**  
ANODIZED

-  **SN** - satnat
-  **D** - chrome
-  **D6** - brass gold

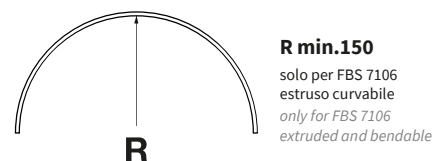
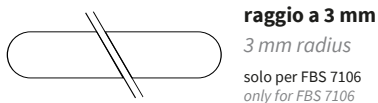
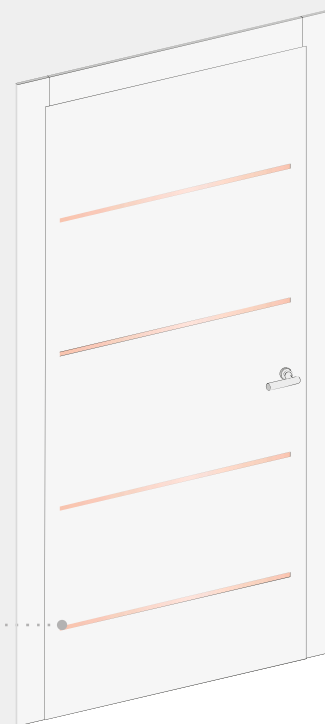
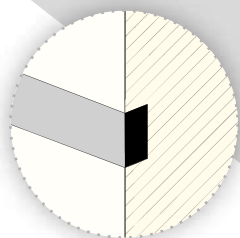

## Modelli Options

misure in mm  
dimensions in mm

**CODICE**  
CODE

**CODICE**  
CODE

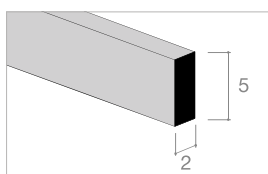

**FBS 7520**  
Aste standard mm 2500  
Standard bars mm 2500

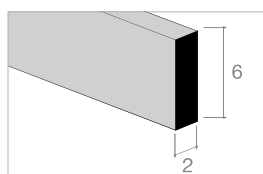

**FBS 7106**  
Estruso curvabile  
Extruded bendable  
Aste standard di mm 2500 e 3000  
Standard bars mm 2500 and 3000

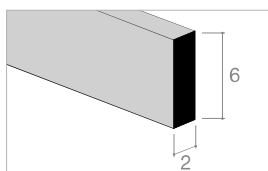

**FBS 7106**  
Aste standard di mm 2500 e 3000  
Standard bars mm 2500 and 3000

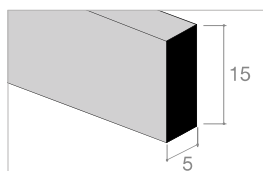

**FBS 7215**  
Aste standard mm 3000  
Standard bars mm 3000

Possibilità di avere i profili già tagliati a misura anche con raggiatura e biadesivo  
*It is possible to have the profiles already cut to size with radial and self-adhesive tape*



## PROFILATI A FREDDO ROLL-FORMED PROFILES

Profili in alluminio  
profilato a freddo  
ideali per la decorazione  
di porte, boiserie e arredo  
*Roll-formed aluminium  
profiles for doors, boiserie  
and furniture*

Lunghezza barre 3000 mm  
Possibilità di fornire i profili  
già tagliati a misura  
*Standard bars 3000 mm  
Cut to size profiles are available*

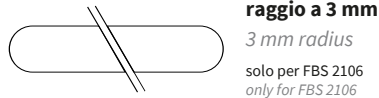
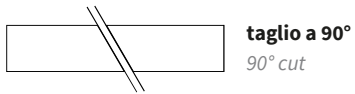
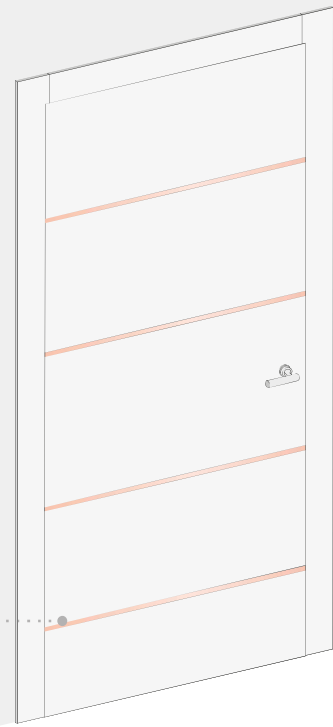
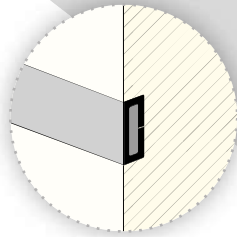

### Modelli *Options*

misure in mm  
dimensions in mm

**CODICE**  
CODE

**CODICE**  
CODE

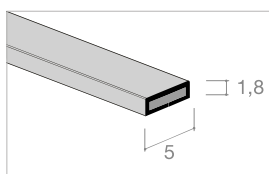

**FBS 2105 ST**

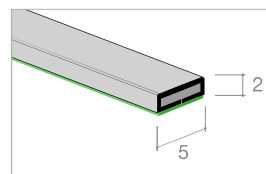

**FBS 2105 BD**  
**BIADESIVO SELF-ADHESIVE**

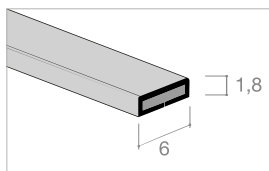

**FBS 2106 ST**

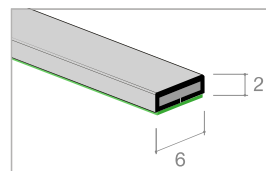

**FBS 2106 BD**  
**BIADESIVO SELF-ADHESIVE**

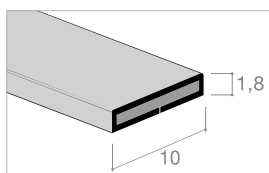

**FBS 2110 ST**

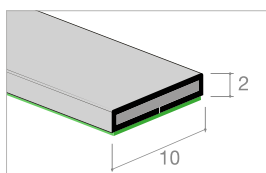

**FBS 2110 BD**  
**BIADESIVO SELF-ADHESIVE**



## PROFILATI A FREDDO ROLL FORMED PROFILES

Profili in alluminio profilato  
a freddo da incasso per porte,  
boiserie e arredo

*Roll-formed aluminium profiles  
for doors, boiserie and furniture*

Lunghezza barre 3000 mm  
Possibilità di fornire i profili  
già tagliati a misura  
Standard bars 3000 mm  
Cut to size profiles are available

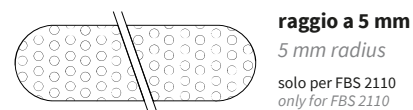
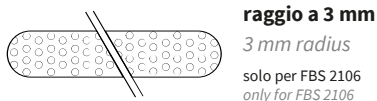
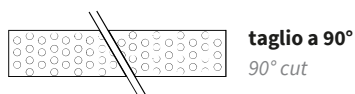
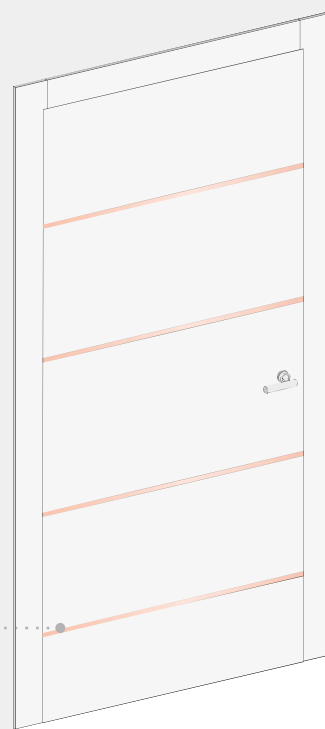
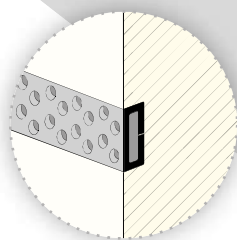

### Modelli *Options*

misure in mm  
dimensions in mm

**CODICE**  
CODE

**CODICE**  
CODE

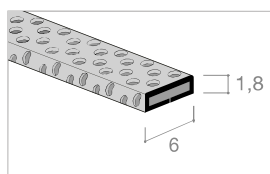

**FBS 2106 WIND ST**

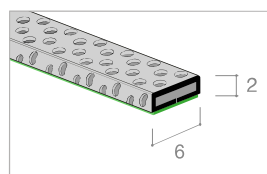

**FBS 2106 BD  
WIND BIADESIVO**  
WIND SELF-ADHESIVE

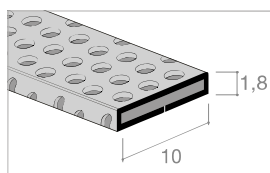

**FBS 2110 WIND ST**

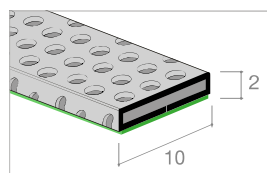

**FBS 2110 BD  
WIND BIADESIVO**  
WIND SELF-ADHESIVE

### Combinazioni colori *Colour combinations*

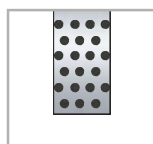

**SN WIND  
L2**

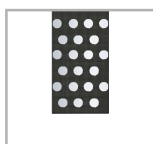

**L1 WIND  
SN**

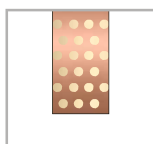

**RA WIND  
B3**

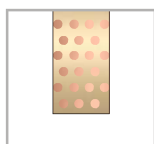

**B3 WIND  
RA**

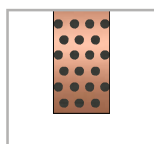

**RA WIND  
L2**

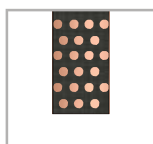

**L2 WIND  
RA**

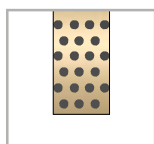

**B3 WIND  
U9**

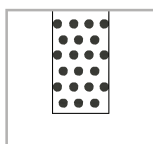

**M1 WIND  
L2**

# BANDELLE STRIPS

Bandelle autoadesive per porte,  
infissi e arredamento

*Self-adhesive strips for doors,  
window frames and furniture*

Lunghezza barre 3000 mm  
Possibilità di fornire le bandelle  
già tagliate a misura  
*Standard bars 3000 mm  
Cut to size strips are available*



**STANDARD**  
taglio a 90°  
*90° cut*

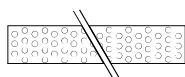

**WIND**  
taglio a 90°  
*90° cut*

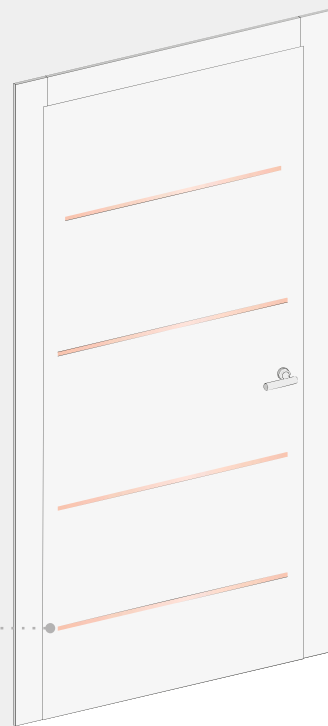
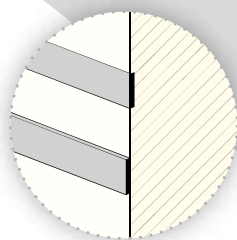

## Modelli *Options*

misure in mm  
*dimensions in mm*

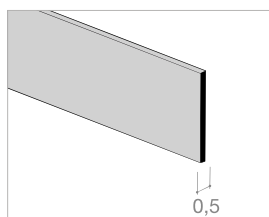

**BANDELLE ST**  
*STANDARD STRIPS*

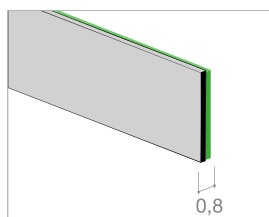

**BANDELLE BD**  
*SELF-ADHESIVE STRIPS*

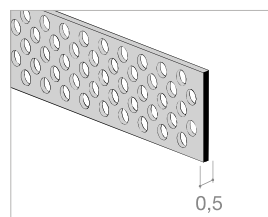

**BANDELLE WIND ST**  
*STANDARD STRIPS*

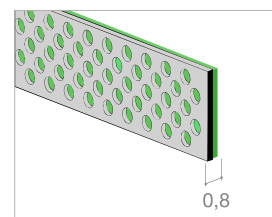

**BANDELLE WIND BD**  
*SELF-ADHESIVE STRIPS*

**CODICE**  
*CODE*

**MISURE**  
*MEASUREMENTS*

**CODICE**  
*CODE*

**MISURE**  
*MEASUREMENTS*

**CODICE**  
*CODE*

**MISURE**  
*MEASUREMENTS*

**CODICE**  
*CODE*

**MISURE**  
*MEASUREMENTS*

<b>FBS 8006 ST</b>	H: 6 mm
<b>FBS 8008 ST</b>	H: 8 mm
<b>FBS 8010 ST</b>	H: 10 mm
<b>FBS 8012 ST</b>	H: 12 mm
<b>FBS 8014 ST</b>	H: 14 mm
<b>FBS 8016 ST</b>	H: 16 mm
<b>FBS 8018 ST</b>	H: 18 mm
<b>FBS 8020 ST</b>	H: 20 mm
<b>FBS 8022 ST</b>	H: 22 mm
<b>FBS 8024 ST</b>	H: 24 mm
<b>FBS 8030 ST</b>	H: 30 mm
<b>FBS 8040 ST</b>	H: 40 mm
<b>FBS 8060 ST</b>	H: 60 mm

<b>FBS 8006 BD</b>	H: 6 mm
<b>FBS 8008 BD</b>	H: 8 mm
<b>FBS 8010 BD</b>	H: 10 mm
<b>FBS 8012 BD</b>	H: 12 mm
<b>FBS 8014 BD</b>	H: 14 mm
<b>FBS 8016 BD</b>	H: 16 mm
<b>FBS 8018 BD</b>	H: 18 mm
<b>FBS 8020 BD</b>	H: 20 mm
<b>FBS 8022 BD</b>	H: 22 mm
<b>FBS 8024 BD</b>	H: 24 mm
<b>FBS 8030 BD</b>	H: 30 mm
<b>FBS 8040 BD</b>	H: 40 mm
<b>FBS 8060 BD</b>	H: 60 mm

<b>FBS 8006 ST</b>	H: 6 mm
<b>FBS 8008 ST</b>	H: 8 mm
<b>FBS 8010 ST</b>	H: 10 mm
<b>FBS 8012 ST</b>	H: 12 mm
<b>FBS 8014 ST</b>	H: 14 mm
<b>FBS 8016 ST</b>	H: 16 mm
<b>FBS 8018 ST</b>	H: 18 mm
<b>FBS 8020 ST</b>	H: 20 mm
<b>FBS 8022 ST</b>	H: 22 mm
<b>FBS 8024 ST</b>	H: 24 mm
<b>FBS 8030 ST</b>	H: 30 mm
<b>FBS 8040 ST</b>	H: 40 mm
<b>FBS 8060 ST</b>	H: 60 mm

<b>FBS 8006 BD</b>	H: 6 mm
<b>FBS 8008 BD</b>	H: 8 mm
<b>FBS 8010 BD</b>	H: 10 mm
<b>FBS 8012 BD</b>	H: 12 mm
<b>FBS 8014 BD</b>	H: 14 mm
<b>FBS 8016 BD</b>	H: 16 mm
<b>FBS 8018 BD</b>	H: 18 mm
<b>FBS 8020 BD</b>	H: 20 mm
<b>FBS 8022 BD</b>	H: 22 mm
<b>FBS 8024 BD</b>	H: 24 mm
<b>FBS 8030 BD</b>	H: 30 mm
<b>FBS 8040 BD</b>	H: 40 mm
<b>FBS 8060 BD</b>	H: 60 mm

Altre misure di larghezza sono disponibili su richiesta fino a 150 mm  
*Other widths sizes are available on request up to 150 mm*



# BANDELLE STRIPS

Bandelle autoadesive per porte,  
infissi e arredamento  
*Self-adhesive strips for doors,  
window frames and furniture*

Possibilità di fornire le bandelle  
già tagliate a misura  
*Cut to size strips are available*

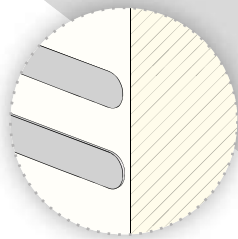
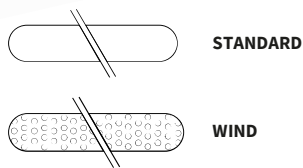

## Modelli *Options*

misure in mm  
 dimensions in mm

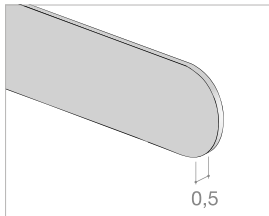

**BANDELLE ST**  
STANDARD STRIPS

**CODICE**  
CODE

**MISURE**  
MEASUREMENTS

**FBS 8006 ST** H: 6 mm  
**R3** R: 3 mm

**FBS 8008 ST** H: 8 mm  
**R4** R: 4 mm

**FBS 8010 ST** H: 10 mm  
**R5** R: 5 mm

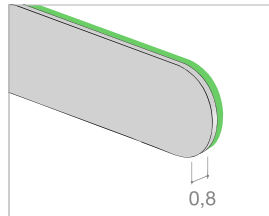

**BANDELLE BD**  
SELF-ADHESIVE STRIPS

**CODICE**  
CODE

**MISURE**  
MEASUREMENTS

**FBS 8006 BD** H: 6 mm  
**R3** R: 3 mm

**FBS 8008 BD** H: 8 mm  
**R4** R: 4 mm

**FBS 8010 BD** H: 10 mm  
**R5** R: 5 mm

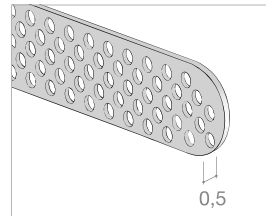

**BANDELLE WIND**  
STANDARD STRIPS

**CODICE**  
CODE

**MISURE**  
MEASUREMENTS

**FBS 8006 ST** H: 6 mm  
**R3** R: 3 mm

**FBS 8008 ST** H: 8 mm  
**R4** R: 4 mm

**FBS 8010 ST** H: 10 mm  
**R5** R: 5 mm

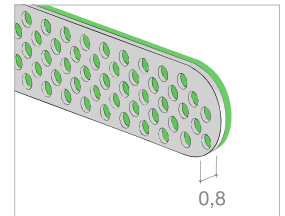

**WIND BIADESIVO**  
SELF-ADHESIVE STRIPS

**CODICE**  
CODE

**MISURE**  
MEASUREMENTS

**FBS 8006 BD** H: 6 mm  
**R3** R: 3 mm

**FBS 8008 BD** H: 8 mm  
**R4** R: 4 mm

**FBS 8010 BD** H: 10 mm  
**R5** R: 5 mm





# PROFILI AUTOADESIVI PER VETRO

## SELF-ADHESIVE PROFILES FOR GLASS

Profili con biadesivo  
per porte a vetro  
*Self-adhesive profiles  
for glass doors*

Lunghezza barre 3000 mm  
Possibilità di fornire i profili  
già tagliati a misura  
*Standard bars 3000 mm  
Cut to size profiles are available*

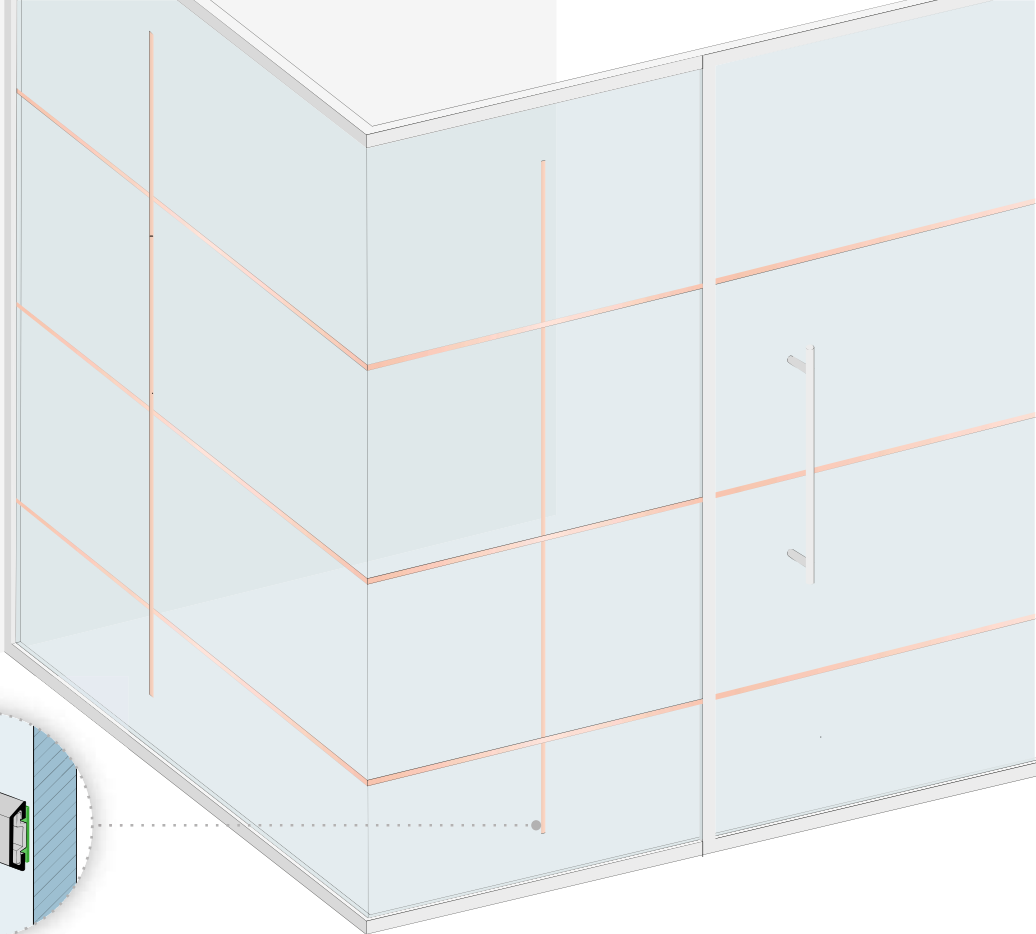

### Modelli Options

misure in mm  
*dimensions in mm*

**CODICE**  
*CODE*

**FISSAGGIO**  
*MOUNTING*

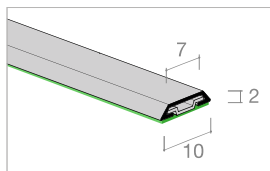

**FBS 2038**



**1. Pulire accuratamente  
la superficie**  
*Thoroughly clean  
the surface*

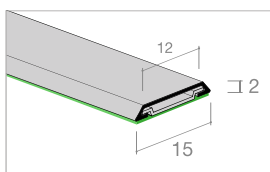

**FBS 2040**

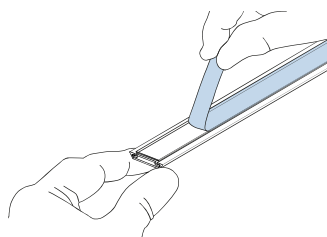

**2. Rimuovere il film  
del biadesivo**  
*Remove film from  
the self-adhesive strip*

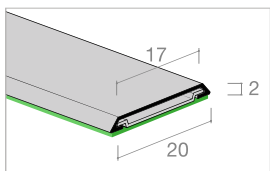

**FBS 2041**

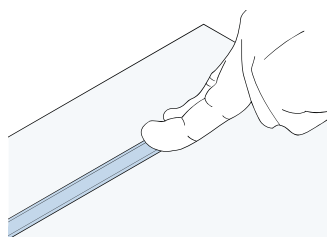

**3. Incollare con una  
leggera pressione il profilo  
sulla superficie**  
*Stick the profile onto  
the surface applying  
a light pressure*









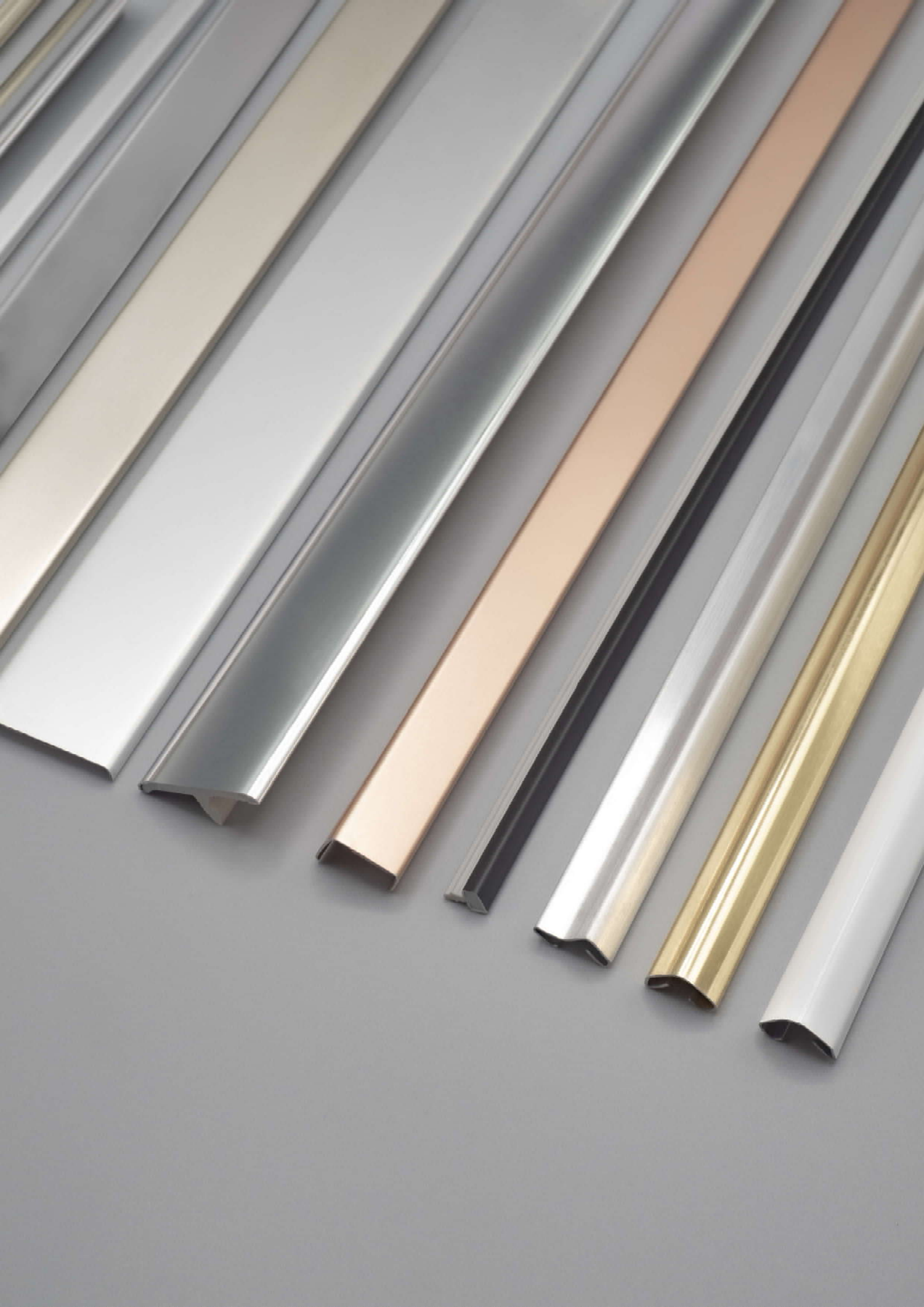

## PROFILI DECORATIVI

### DECORATIVE PROFILES

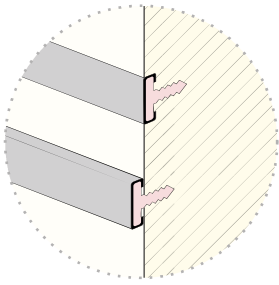

#### PROFILATI A T

T PROFILES

Tipologia di fissaggio a collante

Fixing procedure: by glue

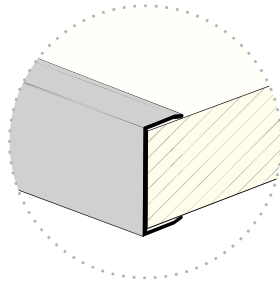

#### BORDI

BORDERS

Tipologia di fissaggio incastro

Fixing procedure: dovetailing

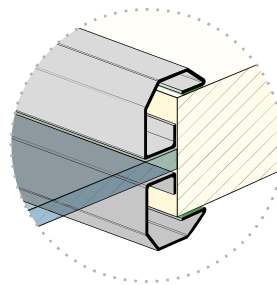

#### FERMAVETRI

GLASS FIX

Tipologia di fissaggio autoadesivo

Fixing procedure: self adhesive

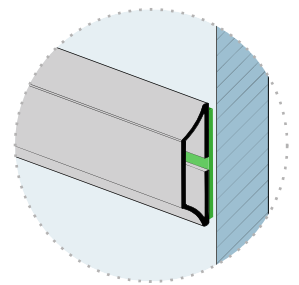

#### PROFILATI DECORATIVI PER VETRO

DECORATIVE PROFILES FOR GLASS

Tipologia di fissaggio autoadesivo

Fixing procedure: self adhesive

## Finiture Finishes

### ANODIZZATI

ANODIZED

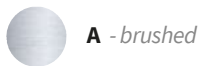

**A** - brushed



**B3** - mill gold



**A2** - inox brushed

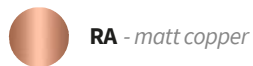

**RA** - matt copper

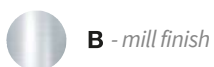

**B** - mill finish



**R2** - polished copper

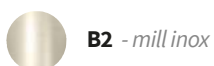

**B2** - mill inox



**D** - chrome



**SN** - sat nat



**D6** - brass gold

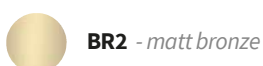

**BR2** - matt bronze



**D2** - polished gold

### PREVERNICIATI

PREPAINTED



**M3** - polished white



**L1** - polished black



**U9** - anthracite

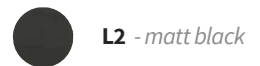

**L2** - matt black



**U5** - alumatt

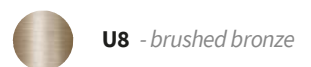

**U8** - brushed bronze



**U6** - inox



**M4** - matt white





## PROFILI A T T PROFILES

Profili in alluminio con gambo a T  
Anima in polistirene rivestita in  
alluminio. Ideale per porte  
boiserie e arredo

*T moulded aluminium profiles  
Aluminum coated polystyrene core  
Ideal for doors, boiserie  
and furniture*

Lunghezza barre 3000 mm.  
Possibilità di fornire i profili  
già tagliati a misura.  
*Standard bars 3000 mm.  
Cut to size profiles also  
available.*

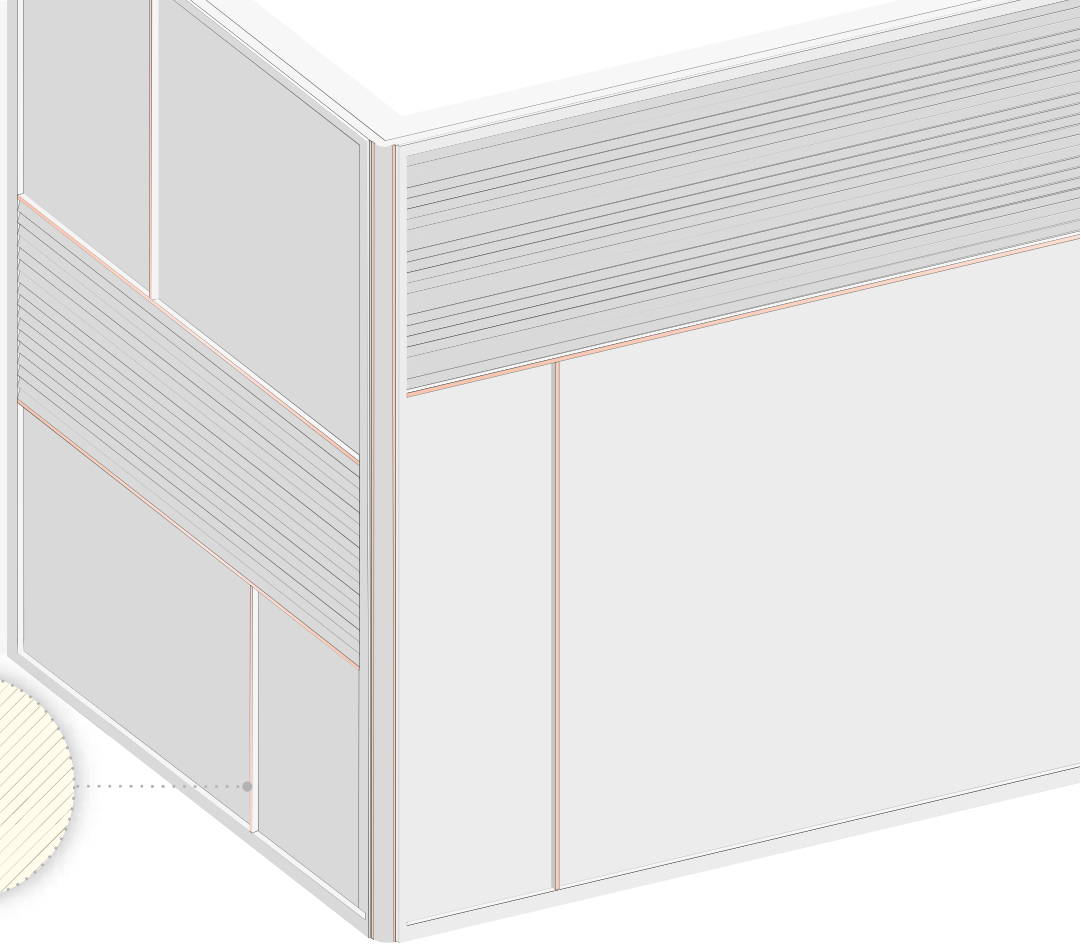
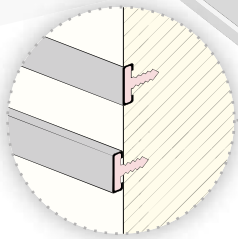

## Modelli Options

misure in mm  
dimensions in mm

**CODICE**  
CODE

**CODICE**  
CODE

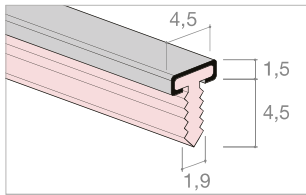

**FBS 3108**

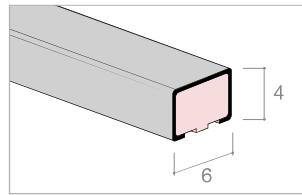

**FBS 3304**

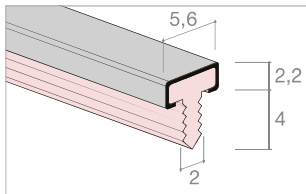

**FBS 3205**

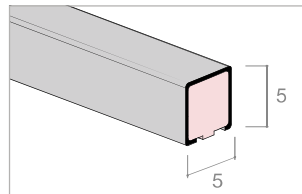

**FBS 3382**

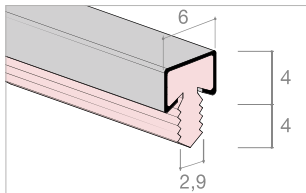

**FBS 3006**

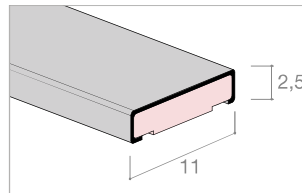

**FBS 3112**

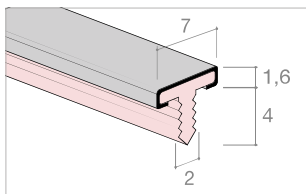

**FBS 3338**

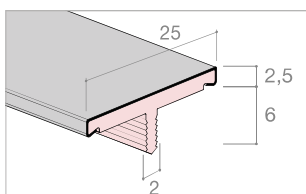

**FBS 3415**

- Polistirene  
Polystyrene
- Alluminio  
Aluminium



## PROFILI A T T PROFILES

Profili in alluminio con gambo a T  
Anima in polistirene rivestita in  
alluminio. Ideale per porte  
boiserie e arredo

*T moulded aluminium profiles.  
Aluminum coated polystyrene core  
Ideal for doors, boiserie  
and furniture*

Lunghezza barre 3000 mm.  
Possibilità di fornire i profili  
già tagliati a misura.  
Standard bars 3000 mm.  
Cut to size profiles also  
available.

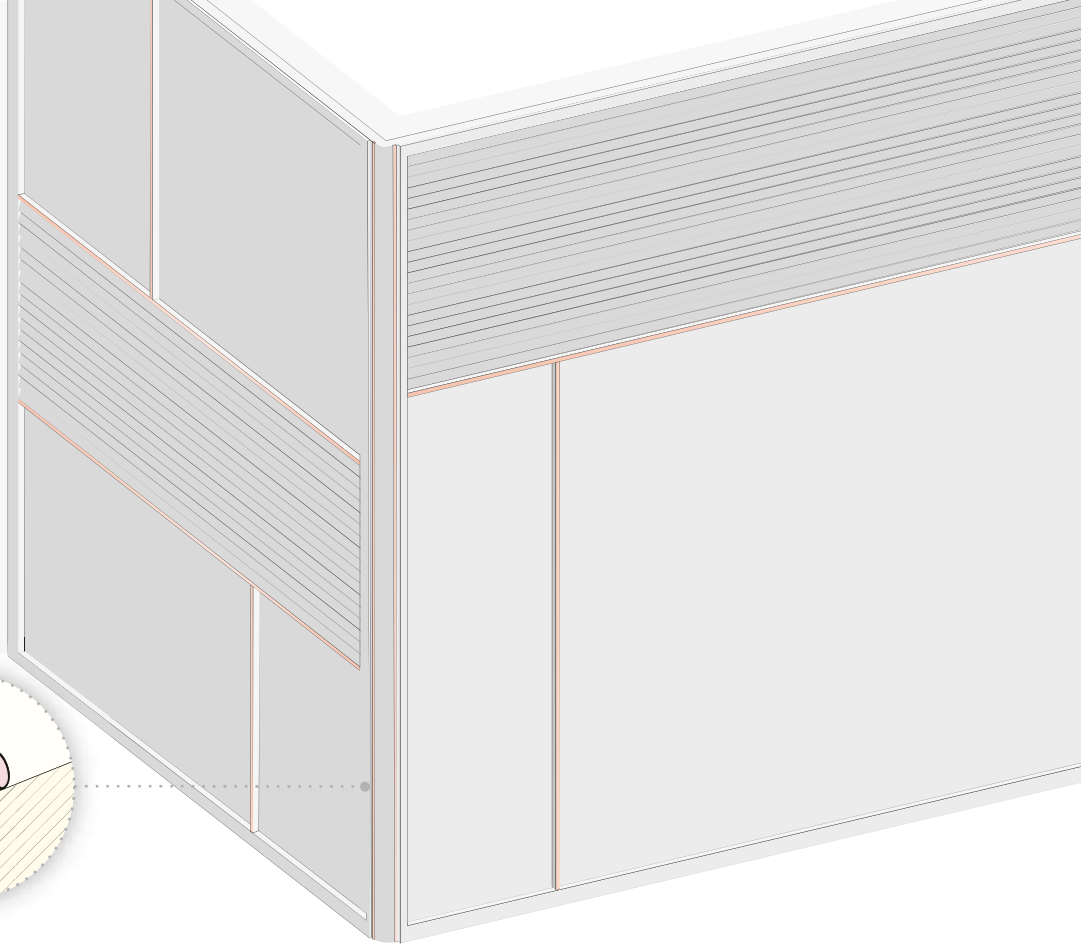
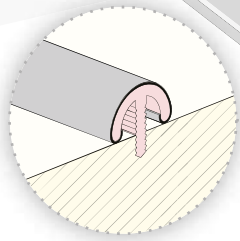

### Modelli Options

misure in mm  
dimensions in mm

**CODICE**  
CODE

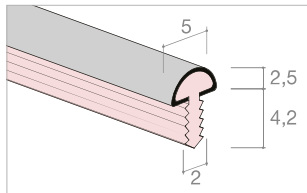

**FBS 3216**

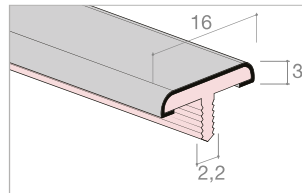

**FBS 3016**

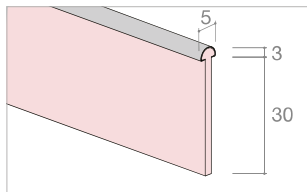

**FBS 3556**

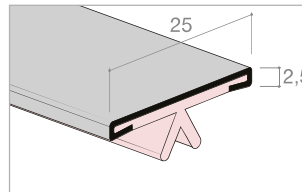

**FBS 3535**

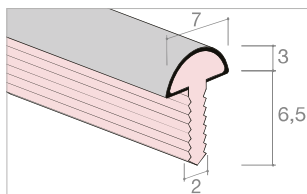

**FBS 3219**

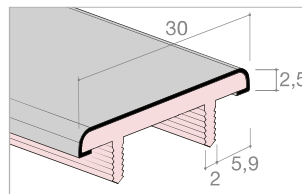

**FBS 3537**

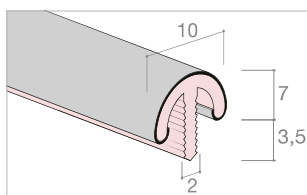

**FBS 3416**

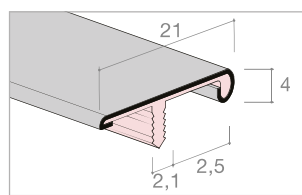

**FBS 3411**

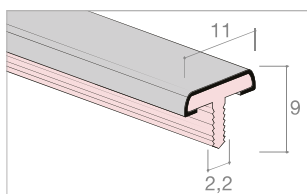

**FBS 3011**

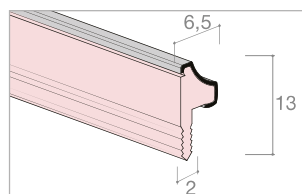

**FBS 3502**

- Polistirene  
Polystyrene
- Alluminio  
Aluminium

## PROFILI A T T PROFILES

Profili in alluminio con gambo  
Anima in polistirene rivestita  
in alluminio. Ideale per pannelli  
*T moulded aluminium profiles*  
*Aluminum coated polystyrene core*  
*Ideal for panels*

Lunghezza barre 3000 mm.  
Possibilità di fornire i profili  
già tagliati a misura.  
*Standard bars 3000 mm.*  
*Cut to size profiles also*  
*available.*

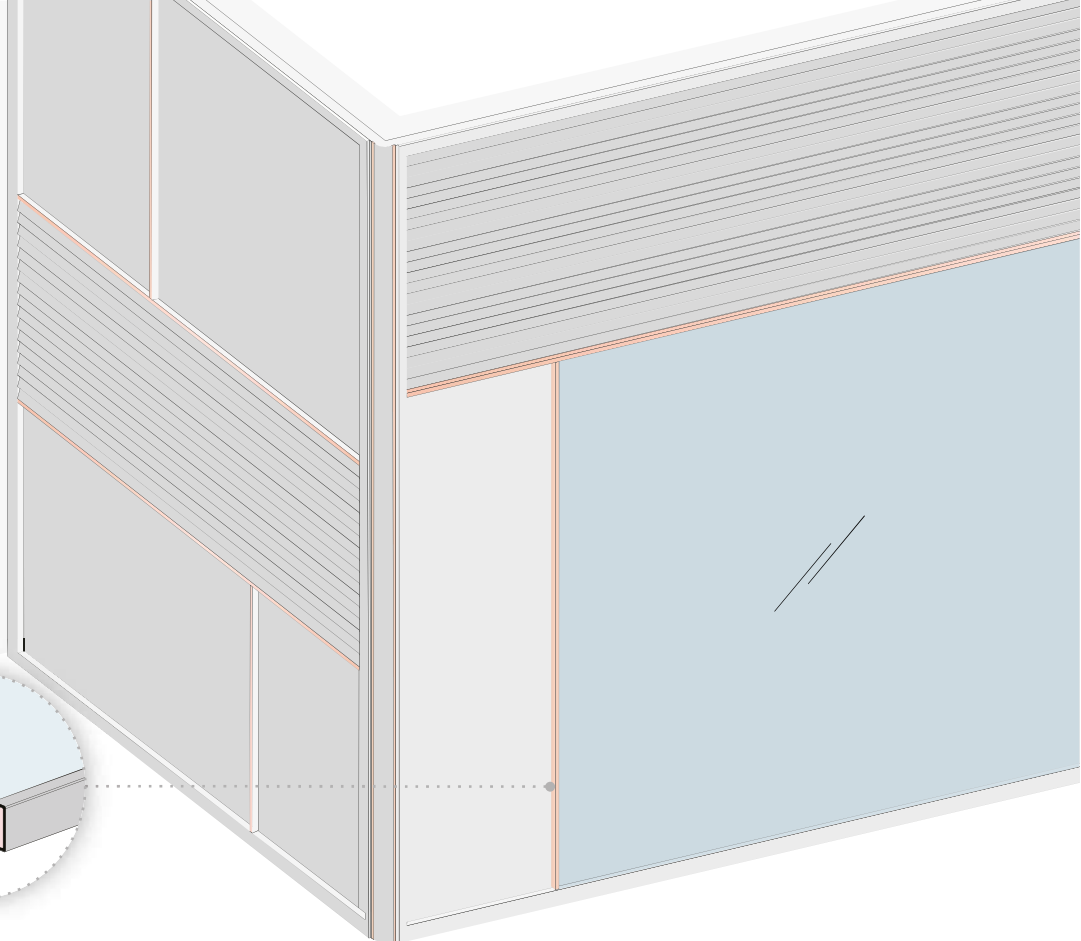
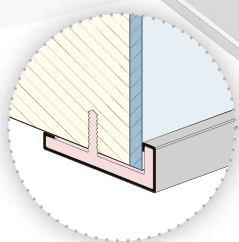

### Modelli Options

misure in mm  
dimensions in mm

CODICE  
CODE

CODICE  
CODE

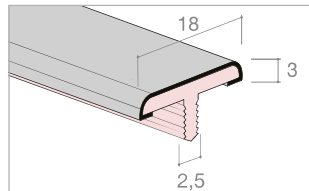

**FBS 3018**

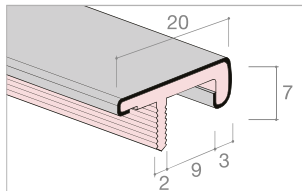

**FBS 3228**

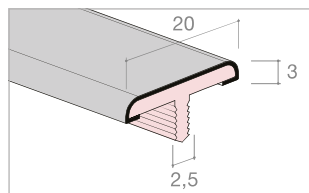

**FBS 3020**

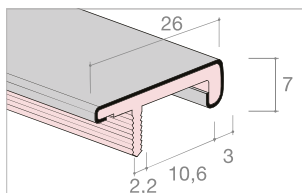

**FBS 3022**

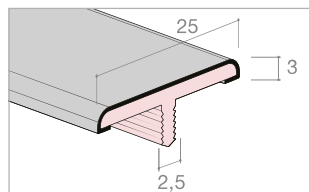

**FBS 3025**

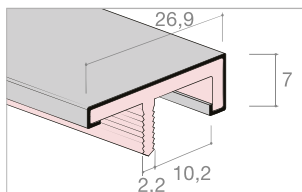

**FBS 3023**

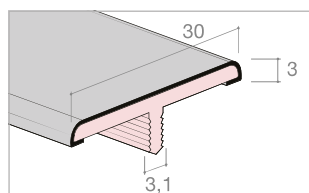

**FBS 3030**

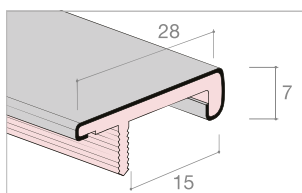

**FBS 3270**

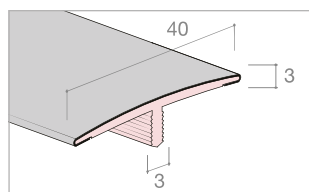

**FBS 3526**

- Polistirene  
Polystyrene
- Alluminio  
Aluminium

## PROFILI PER BORDATURA BORDER PROFILES

Profili in alluminio per  
bordatura vetri e pannelli

*Aluminium border profiles  
for doors, cupboard doors  
and glass partitions*

Lunghezza barre 3000 mm.  
Possibilità di fornire i profili  
già tagliati a misura.  
*Standard bars 3000 mm.  
Cut to size profiles also  
available.*

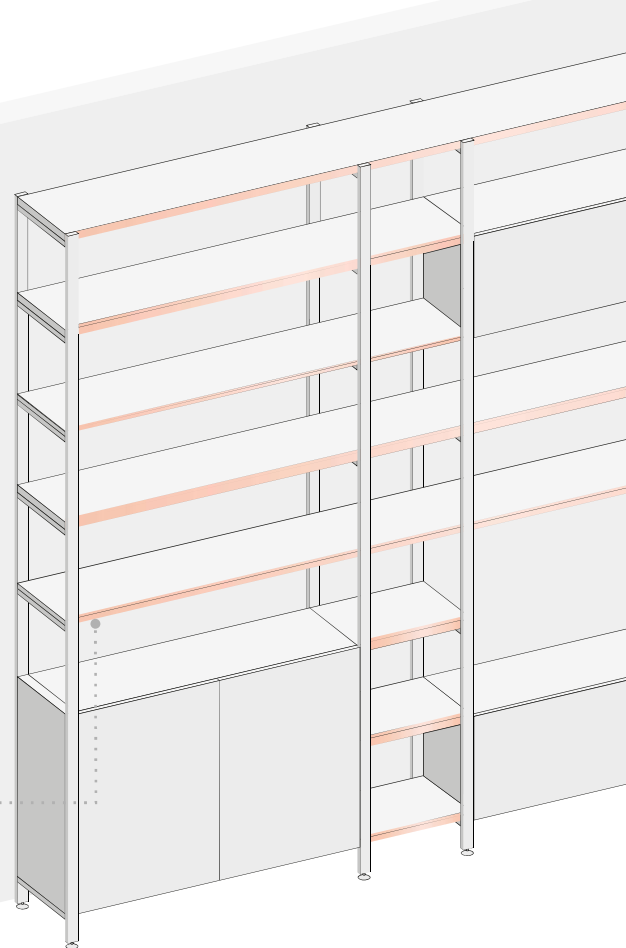
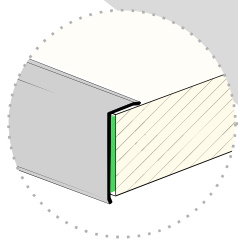

### Modelli *Options*

misure in mm  
*dimensions in mm*

**CODICE**  
*CODE*

**CODICE**  
*CODE*

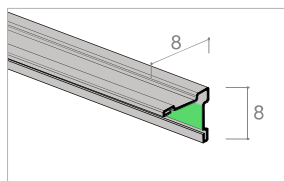

**FBS 1336**

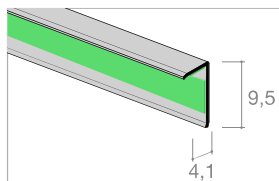

**FBS 1341**

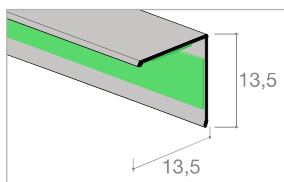

**FBS 1337**

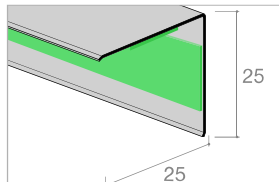

**FBS 1342**

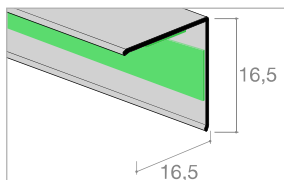

**FBS 1338**

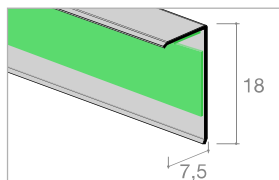

**FBS 1343**

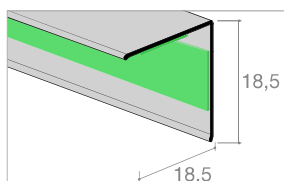

**FBS 1339**

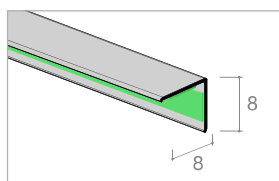

**FBS 1344**

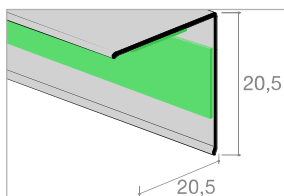

**FBS 1340**

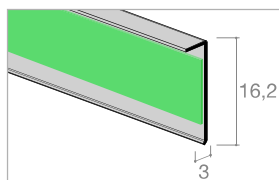

**FBS 1350**

## PROFILI PER BORDATURA BORDER PROFILES

Profili in alluminio per  
bordatura vetri e pannelli

*Aluminium border profiles  
for doors, cupboard doors  
and glass partitions*

Lunghezza barre 3000 mm.  
Possibilità di fornire i profili  
già tagliati a misura.  
*Standard bars 3000 mm.  
Cut to size profiles also  
available.*

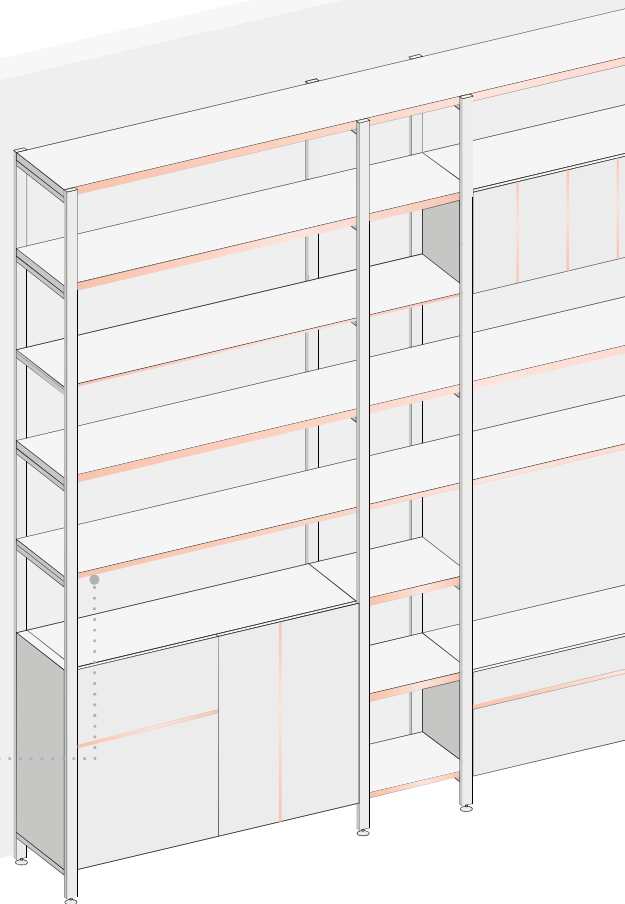
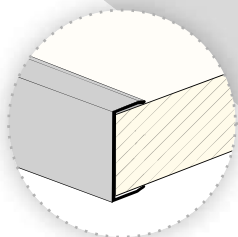

### Modelli *Options*

misure in mm  
*dimensions in mm*

**CODICE**  
*CODE*

**CODICE**  
*CODE*

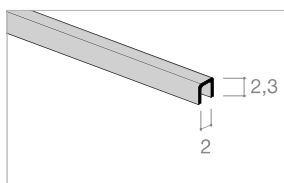

**FBS 1002**

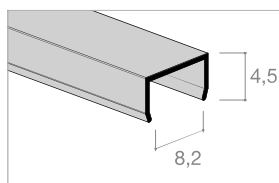

**FBS 1008**

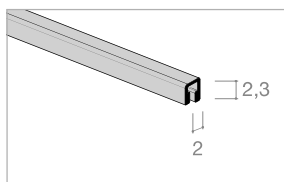

**FBS 2052**

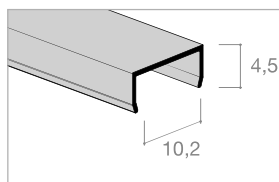

**FBS 1010**

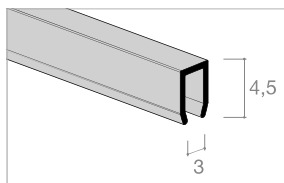

**FBS 1003**

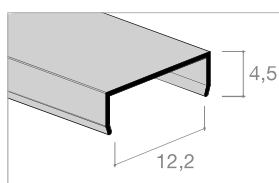

**FBS 1012**

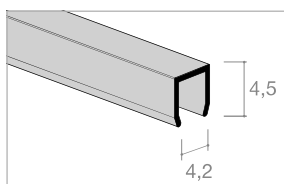

**FBS 1004**

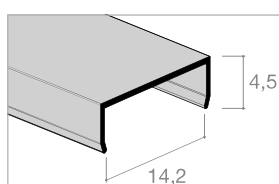

**FBS 1014**

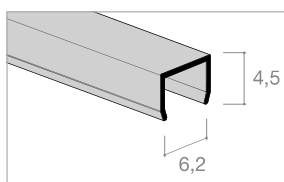

**FBS 1006**

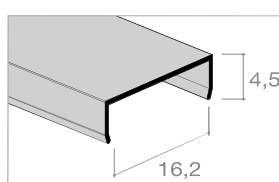

**FBS 1016**

## PROFILI PER BORDATURA BORDER PROFILES

Profili in alluminio per  
bordatura vetri e pannelli

*Aluminium border profiles  
for doors, cupboard doors  
and glass partitions*

Lunghezza barre 3000 mm.  
Possibilità di fornire i profili  
già tagliati a misura.  
*Standard bars 3000 mm.  
Cut to size profiles also  
available.*

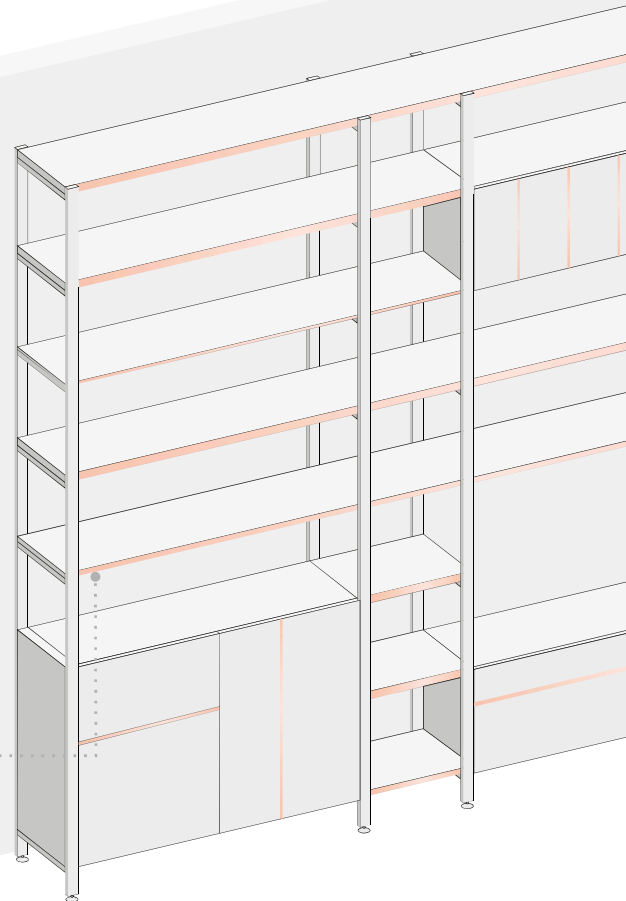
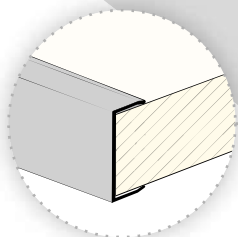

### Modelli *Options*

misure in mm  
*dimensions in mm*

**CODICE**  
*CODE*

**CODICE**  
*CODE*

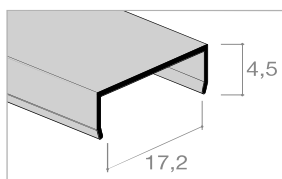

**FBS 1017**

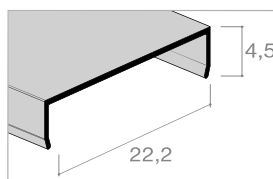

**FBS 1022**

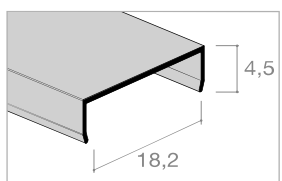

**FBS 1018**

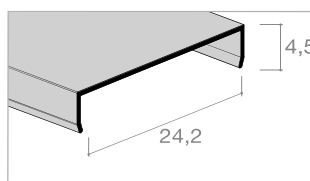

**FBS 1024**

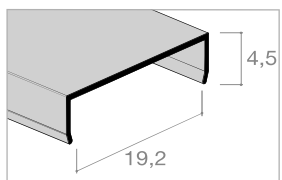

**FBS 1019**

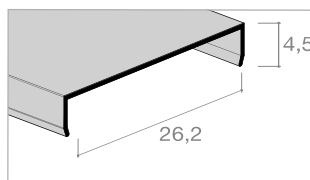

**FBS 1026**

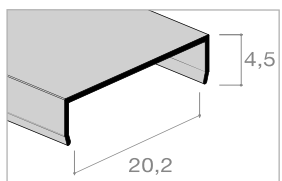

**FBS 1020**

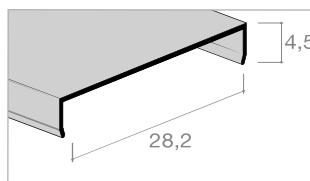

**FBS 1028**

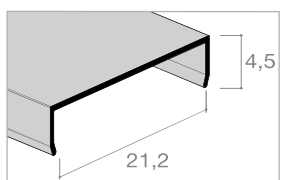

**FBS 1021**

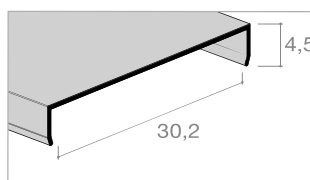

**FBS 1030**

## PROFILI PER BORDATURA BORDER PROFILES

Profili in alluminio per  
bordatura vetri e pannelli

*Aluminium border profiles  
for doors, cupboard doors  
and glass partitions*

Lunghezza barre 3000 mm.  
Possibilità di fornire i profili  
già tagliati a misura.  
*Standard bars 3000 mm.  
Cut to size profiles also  
available.*

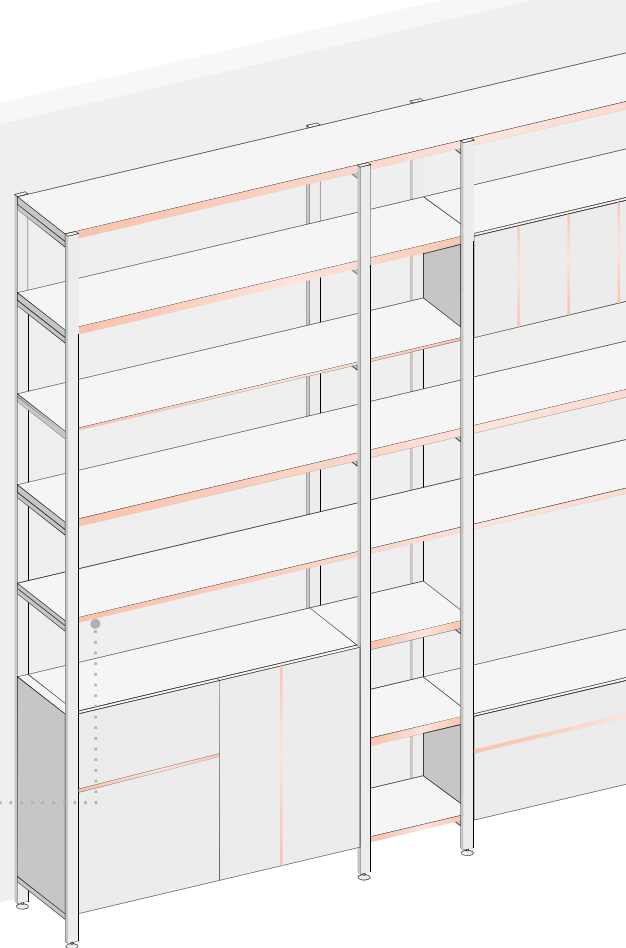
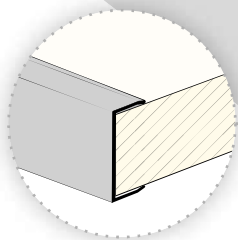

### Modelli *Options*

misure in mm  
*dimensions in mm*

**CODICE**  
*CODE*

**CODICE**  
*CODE*

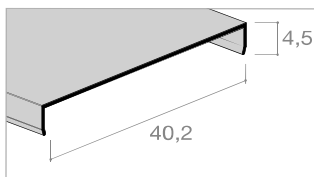

**FBS 1040**

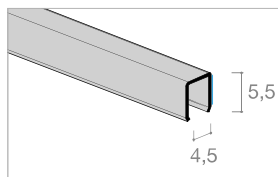

**FBS 1404**

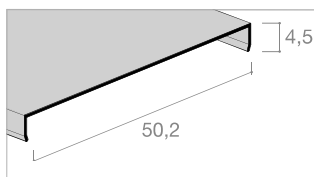

**FBS 1050**

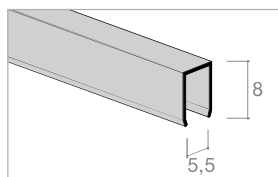

**FBS 1205**

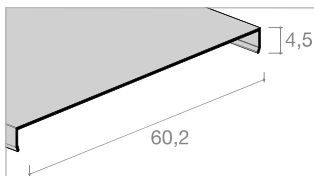

**FBS 1060**

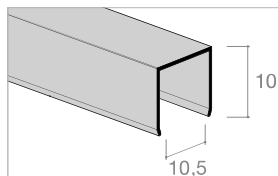

**FBS 1210**

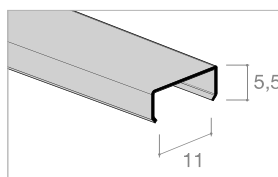

**FBS 1211**

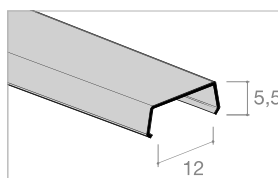

**FBS 1212**

## PROFILI PER BORDATURA BORDER PROFILES

Profili in alluminio per  
bordatura vetri e pannelli

*Aluminium border profiles  
for doors, cupboard doors  
and glass partitions*

Lunghezza barre 3000 mm.  
Possibilità di fornire i profili  
già tagliati a misura.  
*Standard bars 3000 mm.  
Cut to size profiles also  
available.*

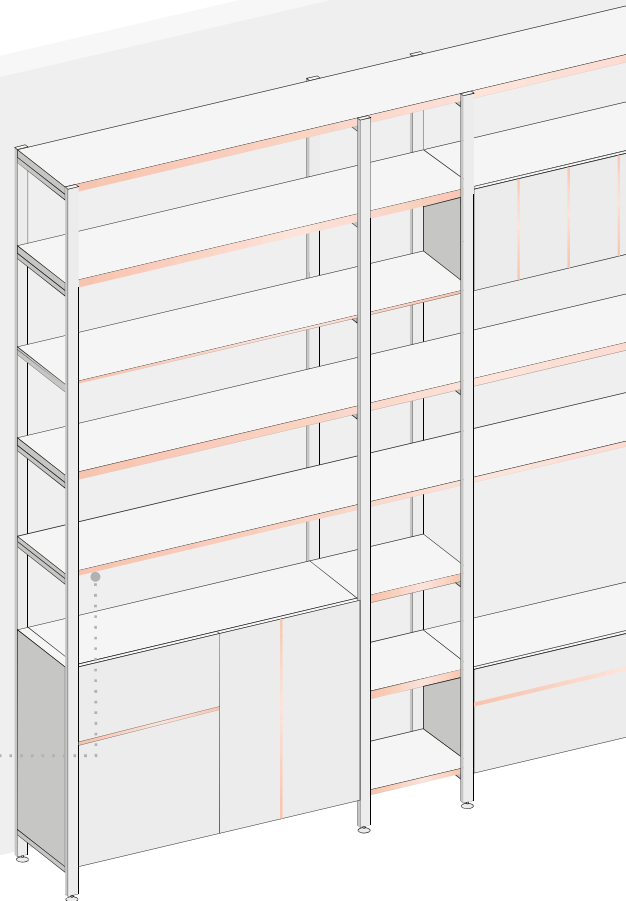
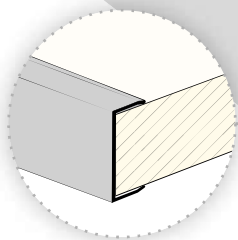

### Modelli *Options*

misure in mm  
*dimensions in mm*

**CODICE**  
*CODE*

**CODICE**  
*CODE*

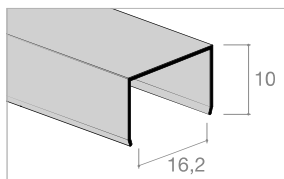

**FBS 1216**

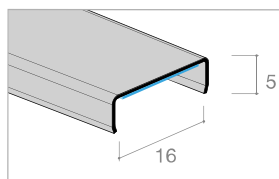

**FBS 2021**

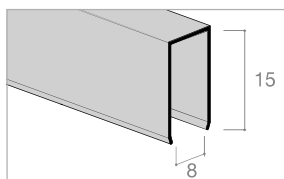

**FBS 1208**

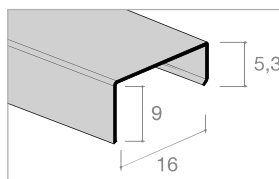

**FBS 2022**

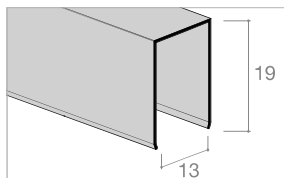

**FBS 1215**

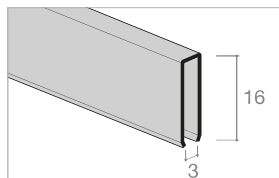

**FBS 2023**

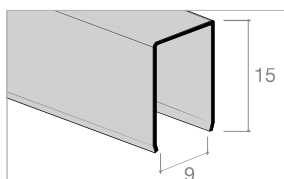

**FBS 1218**

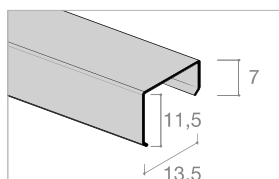

**FBS 1220**

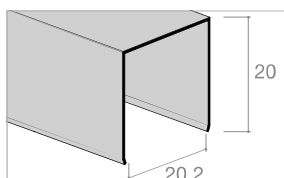

**FBS 1220**

## PROFILI SPECIALI SPECIAL PROFILES

Profili in alluminio per  
raccordo di pareti  
e pavimenti

*Aluminium conneting profiles  
for walls and floors*

Lunghezza barre 3000 mm.  
Possibilità di fornire i profili  
già tagliati a misura.  
*Standard bars 3000 mm.  
Cut to size profiles also  
available.*

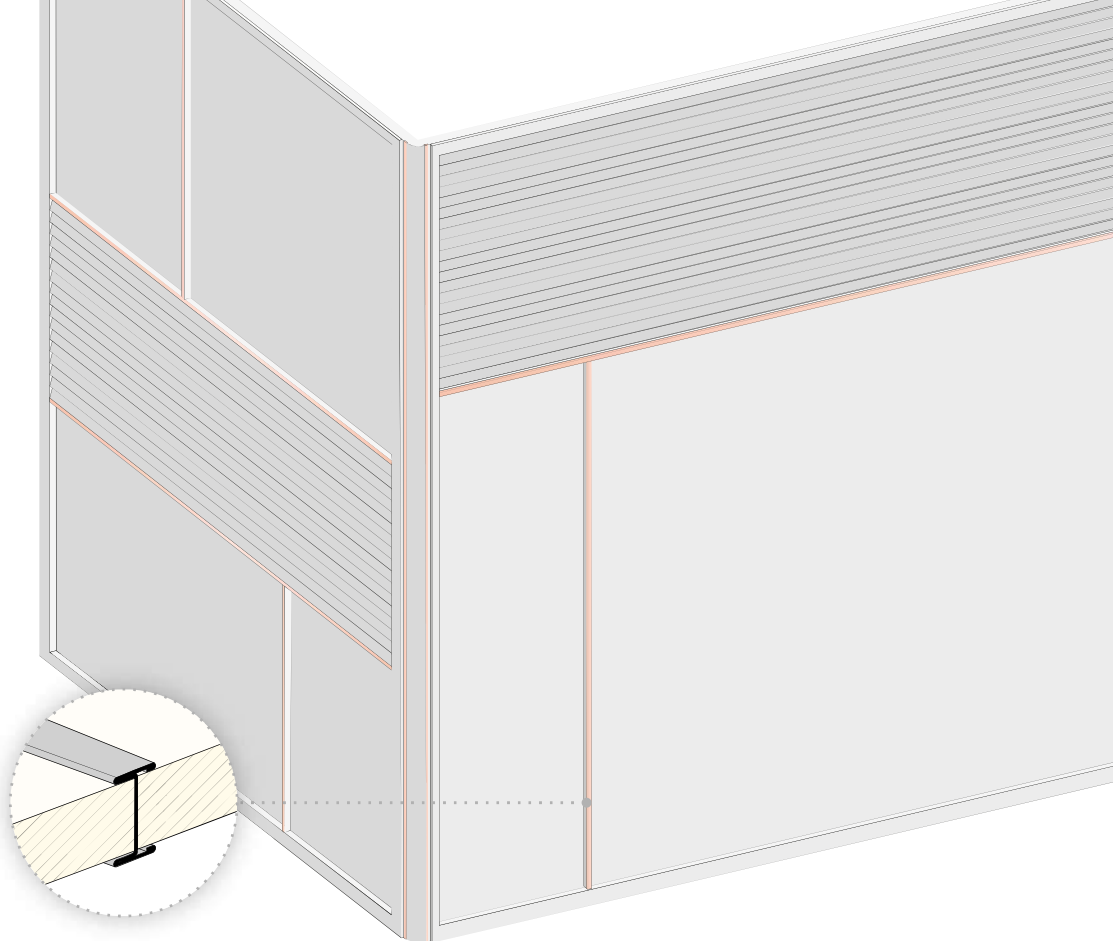

### Modelli *Options*

misure in mm  
*dimensions in mm*

**CODICE**  
*CODE*

**CODICE**  
*CODE*

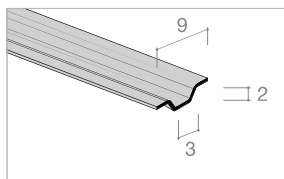

**FBS 1501**

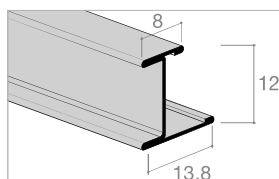

**FBS 2017**

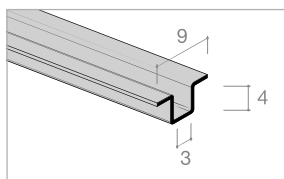

**FBS 2019**

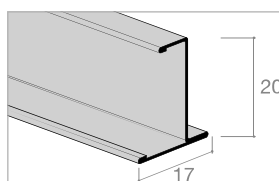

**FBS 2018**

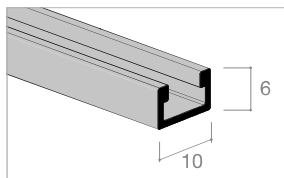

**FBS 2015**

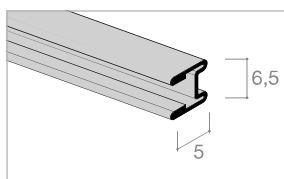

**FBS 2061**

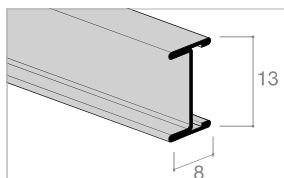

**FBS 2016**









# FERMAVETRI GLASS-FIX

Profili decorativi fermavetro  
con biadesivo

*Aluminium self-adhesive  
glass-fix profiles*

Profili fermavetri in Polistirene  
con biadesivo

*Polystyrene self-adhesive  
glass-fix profiles*

Lunghezza barre 3000 mm  
Possibilità di fornire i profili  
già tagliati a misura  
Standard bars 3000 mm  
Cut-to-size profiles also  
available

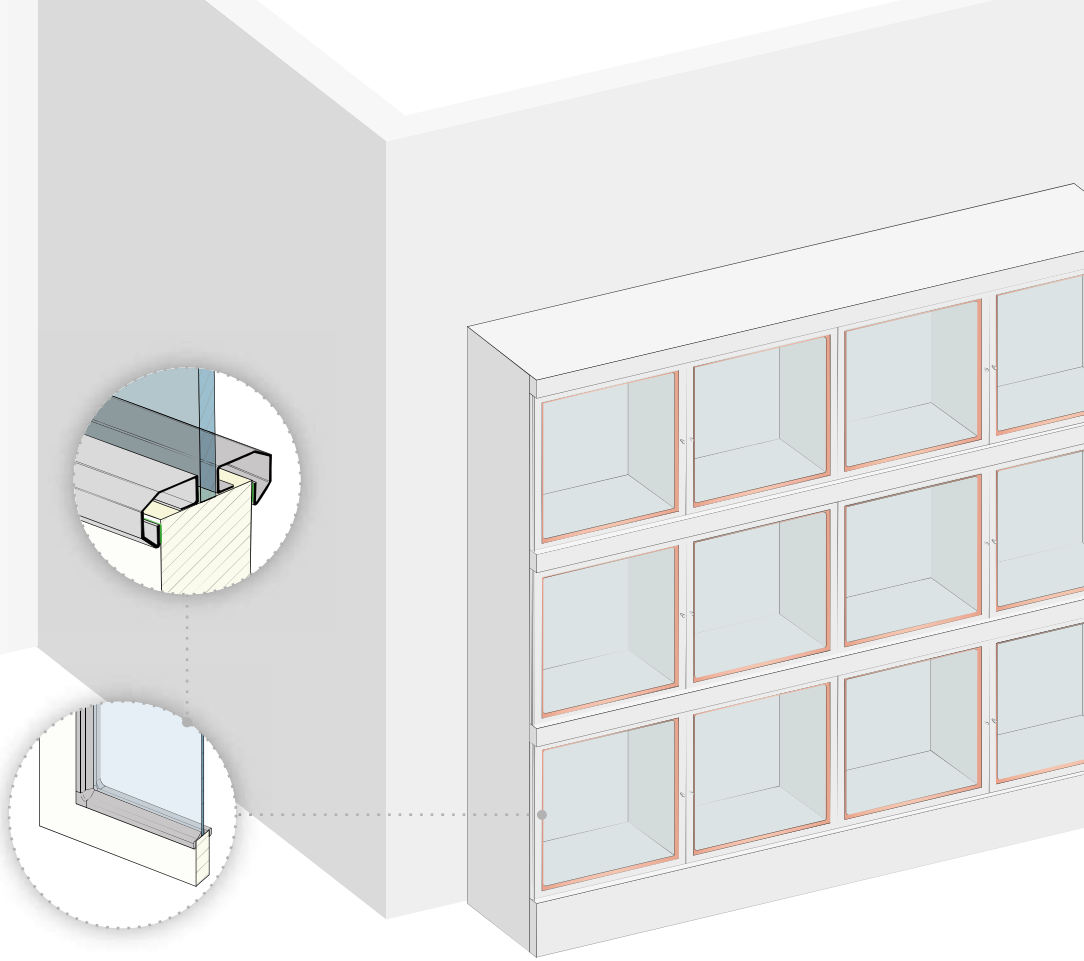

## Modelli Options

misure in mm  
dimensions in mm

**CODICE**  
CODE

**CODICE**  
CODE

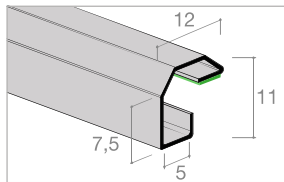

**FBS 1236**

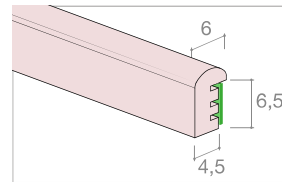
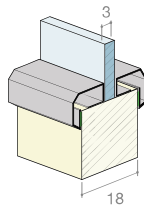

**FBS 6204**

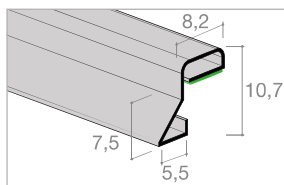
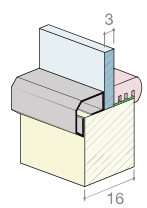

**FBS 2077**

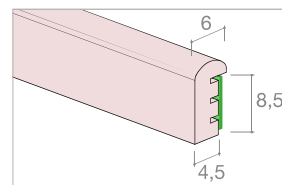
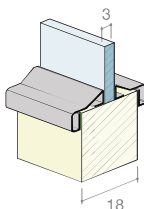

**FBS 6205**

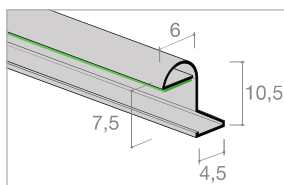
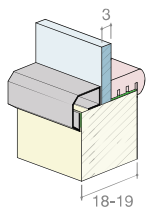

**FBS 2055**

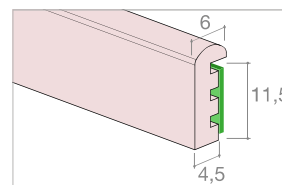
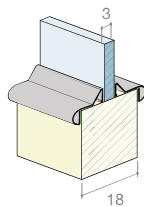

**FBS 6206**

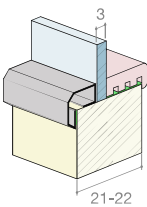

## Angolari in ABS metallizzati *Metallic ABS corner*

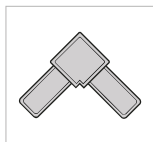

**FBS 9075**  
per for FBS 1236

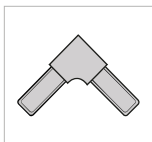

**FBS 9077**  
per for FBS 2077

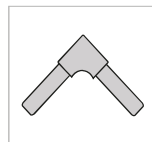

**FBS 9455**  
per for FBS 2055

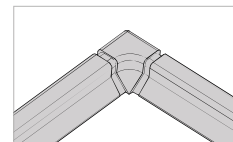

Angolo sagomato antideposito  
*Anti-dirt shaped corner*

- Polistirene  
*Polystyrene*
- Alluminio  
*Aluminium*
- Biadesivo  
*Self-adhesive*

# PROFILI AUTOADESIVI SELF-ADHESIVE PROFILES

Profili decorativi con biadesivo  
per porte, sportelli e vetrate

*Decorative self-adhesive profiles  
for doors, cupboard doors  
and glass partitions*

Lunghezza barre 3000 mm  
Possibilità di fornire i profili  
già tagliati a misura  
*Standard bars 3000 mm  
Cut to size profiles also  
available*

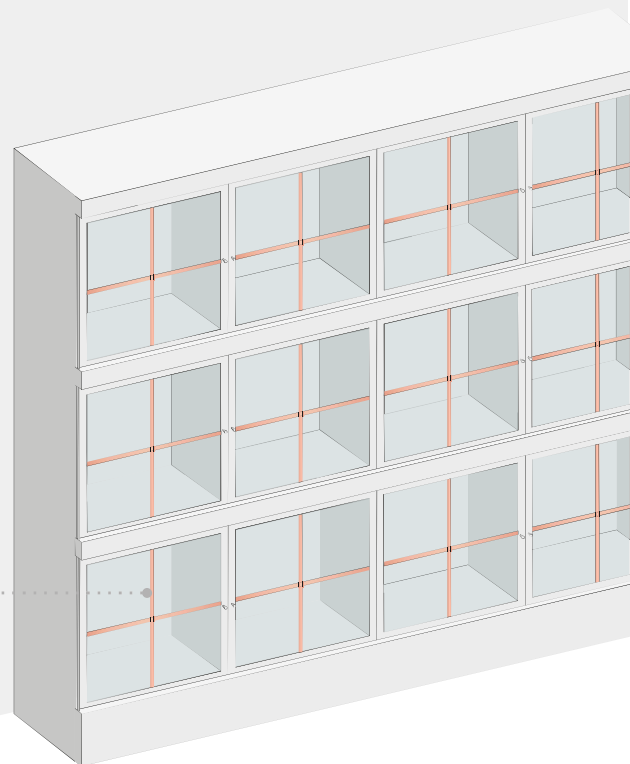
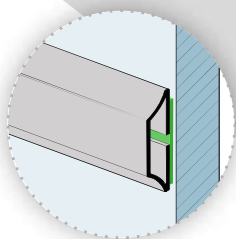

## Modelli Options

misure in mm  
*dimensions in mm*

**CODICE**  
*CODE*

**CODICE**  
*CODE*

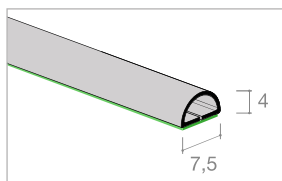

**FBS 918**

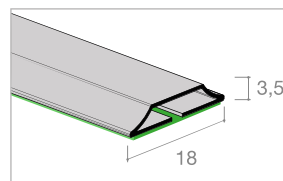

**FBS 1193**

### Accessori in ABS metallizzati per FBS 918-BD *Metallic ABS accessories for FBS 918-BD*

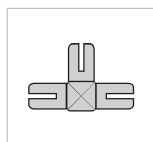

**FBS 9052**

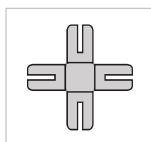

**FBS 9053**

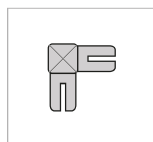

**FBS 9055**

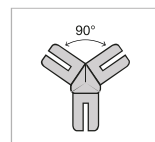

**FBS 9056**

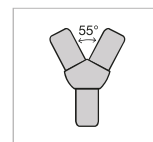

**FBS 9057**

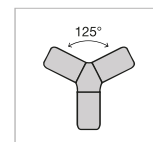

**FBS 9058**

### Accessori in ABS metallizzati per FBS 1193 *Metallic ABS accessories for FBS 1193*

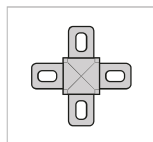

**FBS 9193**

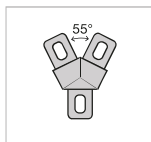

**FBS 9194**

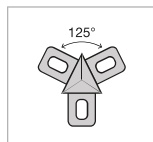

**FBS 9195**

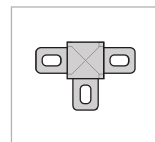

**FBS 9196**

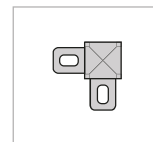

**FBS 9197**

### FISSAGGIO MOUNTING

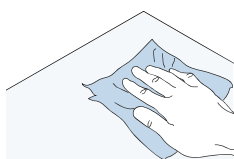

1. Pulire accuratamente  
la superficie  
*Thoroughly clean  
the surface*

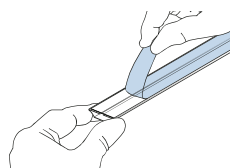

2. Rimuovere il film  
del biadesivo  
*Remove film from  
the self-adhesive strip*

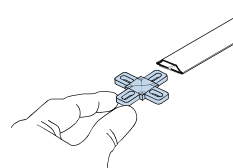

3. Inserire i giunti  
*Insert the joints*

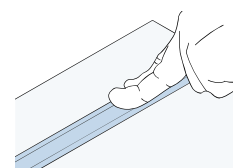

4. Incollare con una  
leggera pressione il profilo  
sulla superficie  
*Stick the profile onto  
the surface applying  
a light pressure*

## PROFILI PER CORNICI STRUCTURAL FRAMES

Specchiere con anima  
in polistirene rivestita  
di alluminio  
*Mirrors with aluminium-coated  
polystyrene core*

Lunghezza barre 3000 mm  
Possibilità di fornire i profili  
già tagliati a misura  
*Standard bars 3000 mm  
Cut to size profiles also  
available*

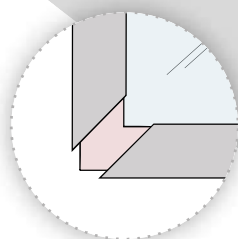

ASSEMBLAGGIO STANDARD  
STANDARD ASSEMBLY

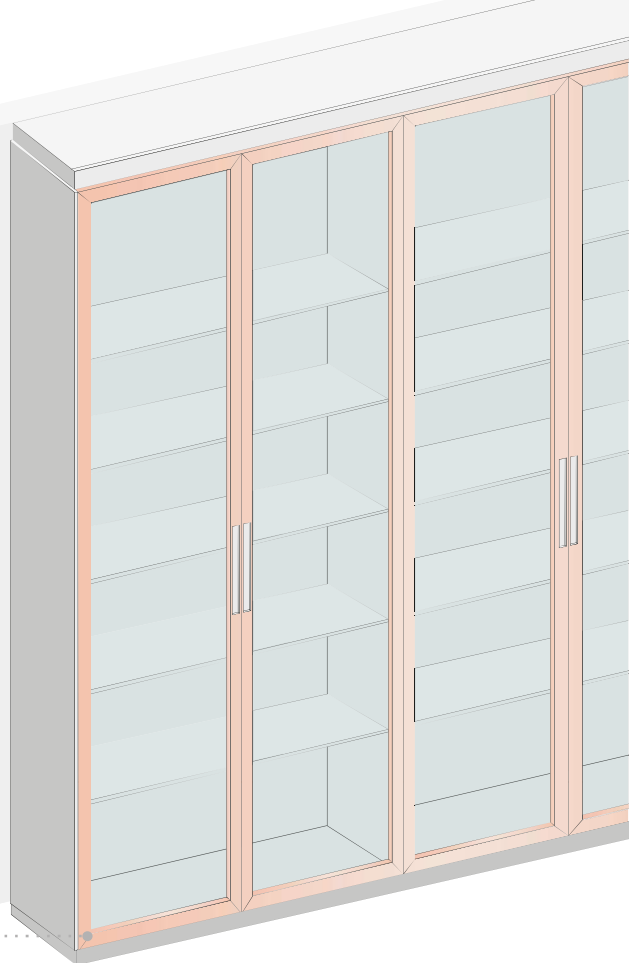

### Modelli Options

misure in mm  
*dimensions in mm*

**CODICE**  
*CODE*

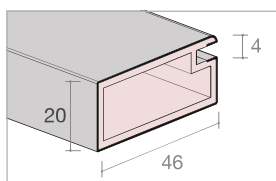

**FBS 3046**  
Profilo perimetrale  
*Frame profile*

● Polistirene  
*Polystyrene*

● Alluminio  
*Aluminium*

### Accessori in ABS ABS accessories

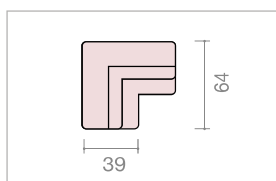

**FBS 9446**  
per for FBS 3046  
Angolo a scomparsa  
*Concealed corner*

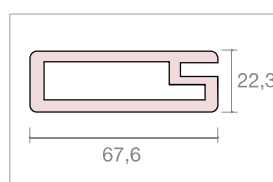

**FBS 9447**  
per for FBS 3046  
Flangia parasigoli  
*Safety flange*

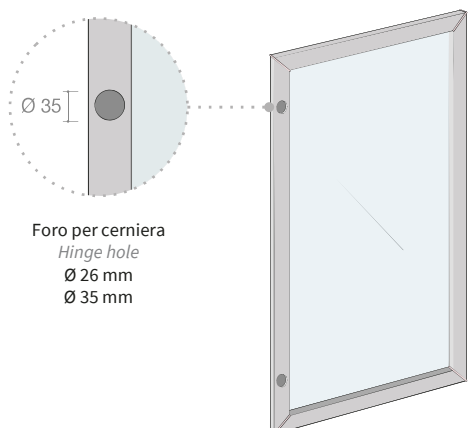

Foro per cerniera  
*Hinge hole*  
Ø 26 mm  
Ø 35 mm

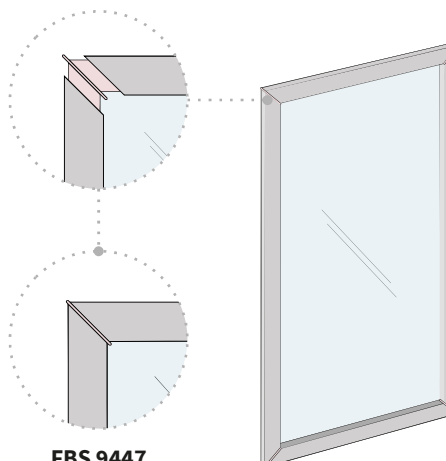

**FBS 9447**  
Assemblaggio  
con flangia  
*Assembly with  
flange*

## PROFILI PER CORNICI STRUCTURAL FRAMES

Specchiere con anima  
in polistirene rivestita  
di alluminio  
*Mirrors with aluminium-coated  
polystyrene core*

Lunghezza barre 3000 mm  
Possibilità di fornire i profili  
già tagliati a misura  
*Standard bars 3000 mm  
Cut to size profiles also  
available*

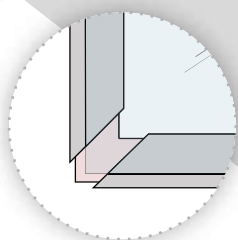

ASSEMBLAGGIO STANDARD  
STANDARD ASSEMBLY

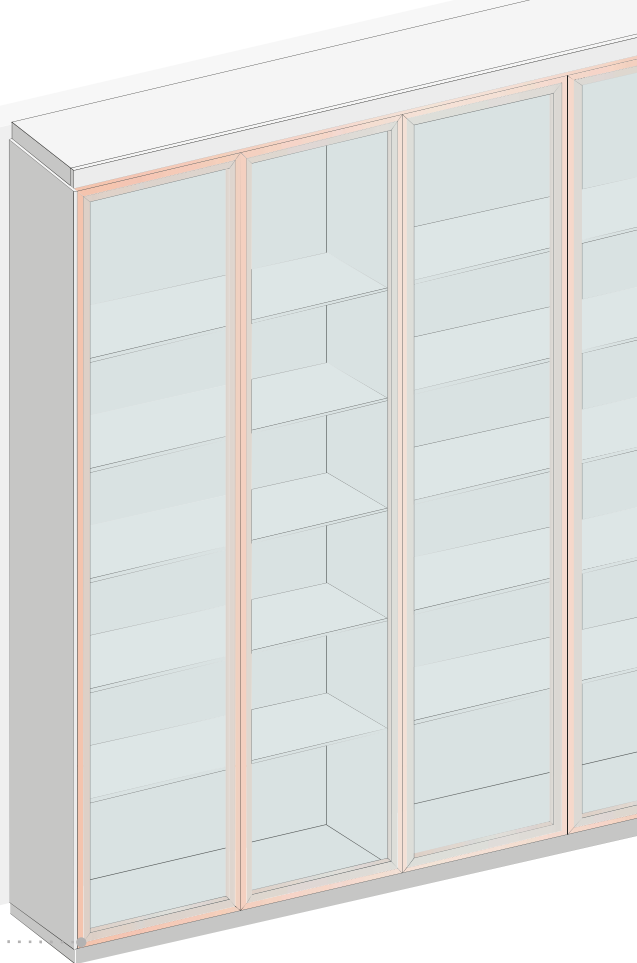

### Modelli Options

misure in mm  
*dimensions in mm*

**CODICE**  
*CODE*

**CODICE**  
*CODE*

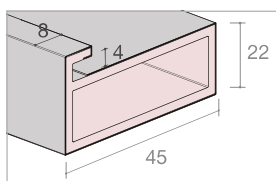

**FBS 3045**  
Profilo perimetrale  
*Frame profile*

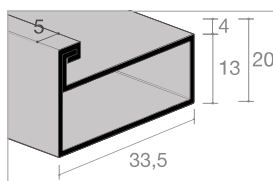

**FBS 2133**  
SAT-NAT

- Polistirene  
*Polystyrene*
- Alluminio  
*Aluminium*

### Accessori in ABS *ABS accessories*

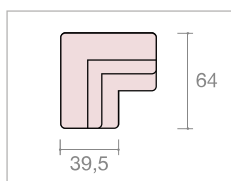

**FBS 9445**  
per for FBS 3045  
Angolo a scomparsa  
*Concealed corner*

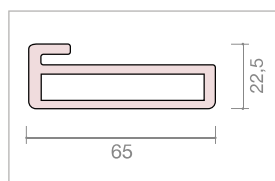

**FBS 9444**  
per for FBS 3045  
Flangia parasigoli  
*Safety flange*

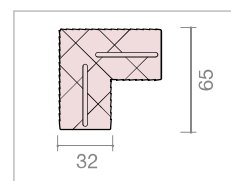

**FBS 9433**  
per for FBS 2133  
Angolo a scomparsa  
*Concealed corner*

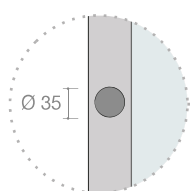

Foro per cerniera  
*Hinge hole*  
Ø 26 mm  
Ø 35 mm

Il foro cerniera  
per FBS 2133  
Ø 26 mm

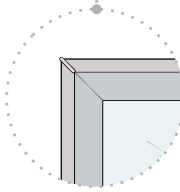
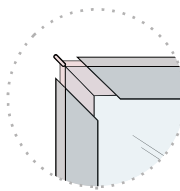
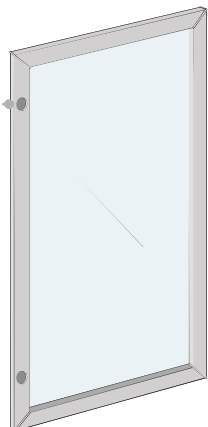

**FBS 9447**  
Assemblaggio  
con flangia  
*Assembly with  
flange*

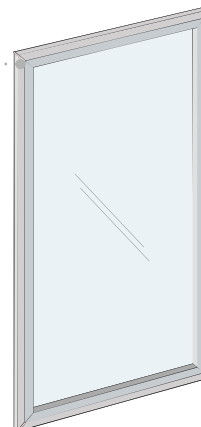

# PROFILI PER RIPIANO PORTA VALIGIE PROFILES FOR LUGGAGE RACK

Profili in alluminio estruso  
Extruded aluminium profiles

Colori disponibili  
Available colours

**ANODIZZATI**  
ANODIZED

-  **SN** - satnat
-  **D** - chrome
-  **D6** - brass gold

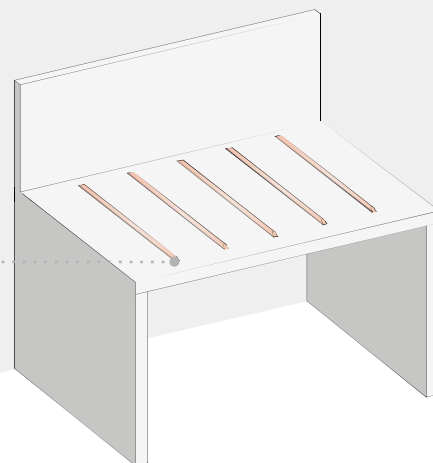
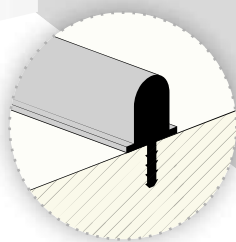

## Opzioni Options

misure in mm  
dimensions in mm

**CODICE**  
CODE

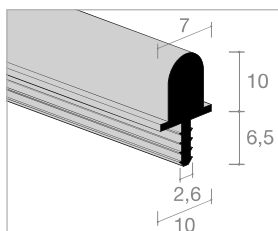

**FBS 7110**

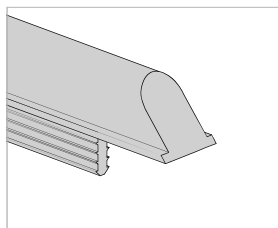

**FBS 7110**  
Taglio a 45°  
45° Cutting

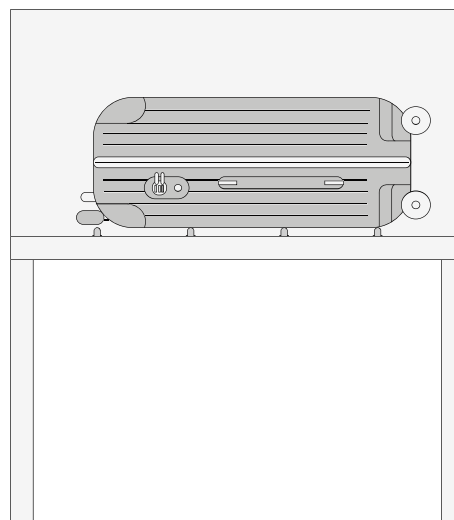

# PROFILO PORTA POSTER POSTER HANGING PROFILE

Profilo in alluminio piegato a freddo  
*Roll formed aluminium profile*

Il profilo è stato progettato  
per i più comuni formati di poster  
*The profile is designed for  
the most popular posters format*

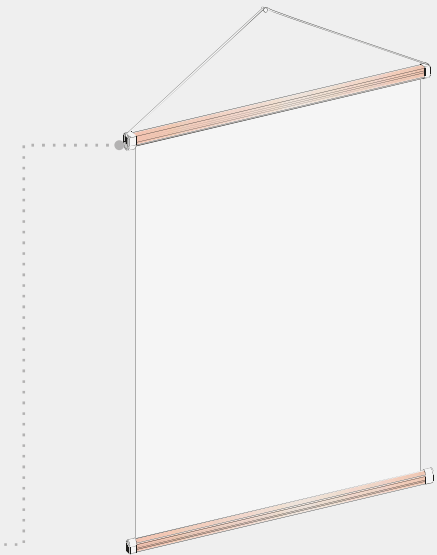
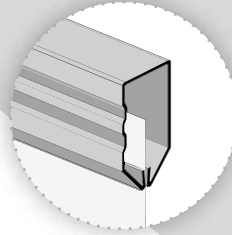
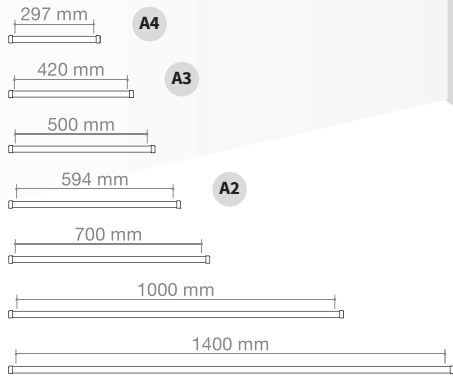

misure in mm  
*dimensions in mm*

**CODICE**  
*CODE*

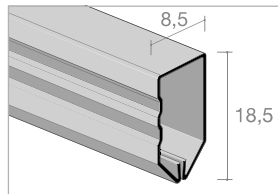

**FBS 200**

**Lato con due scanalature**  
*Side with two grooves*

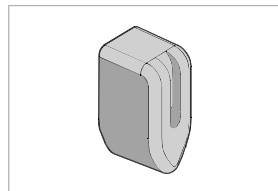
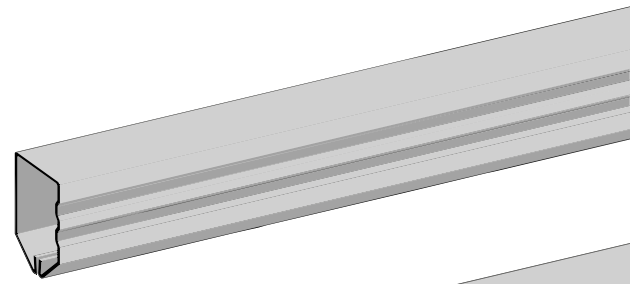

**FBS 9400**

● L2 - *matt black*

**Lato piano**  
*Plain side*

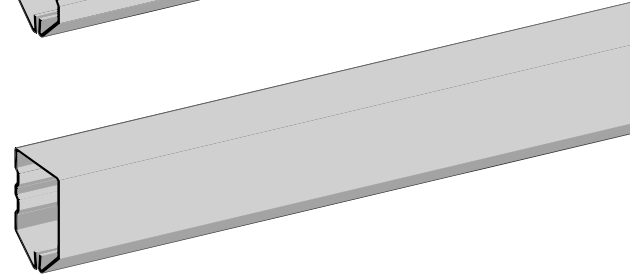

## ISTRUZIONI DI MONTAGGIO MOUNTING INSTRUCTION

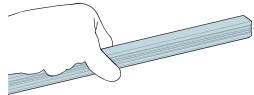

1. Prendere il profilo  
*Take the profile*

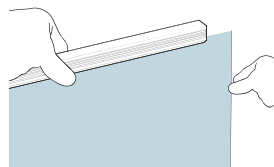

2. Inserire il poster all'interno  
dell'apposita fessura  
*Insert the sheet inside the slot*

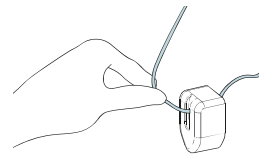

3. Inserire il filo nell'apposito  
foro dei due tappi superiori  
*Insert the thread into the designated  
hole in the two upper end caps*

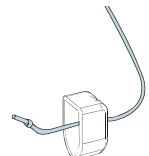

4. Realizzare un nodo  
all'estremità del filo  
*Make a knot at the end  
of the thread*

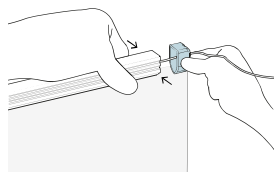

5. Inserire il profilo superiore nei due  
tappi, esercitando una leggera  
pressione *Insert the upper profile in the  
two end caps, applying a light pressure*

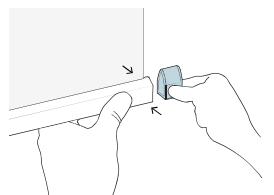

6. Inserire il profilo inferiore nei due  
tappi, esercitando una leggera  
pressione *Insert the lower profile in the  
two end caps, applying a light pressure*

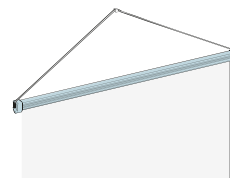

7. Appendere il poster  
*Hang the poster*



## FINITURE *FINISHES*

### ANODIZZATI *ANODIZED*



**A** - brushed



**A2** - inox brushed



**B** - mill finish



**B2** - mill inox

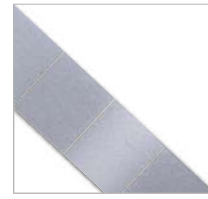

**SN** - sat nat



**BR2** - matt bronze



**B3** - mill gold



**RA** - copper

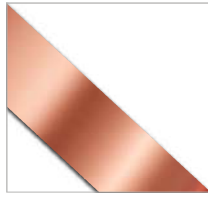

**R2** - polished copper

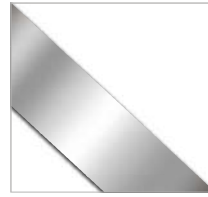

**D** - chrome

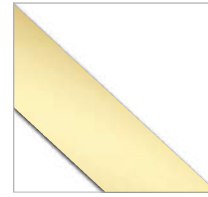

**D2** - polished gold



**D6** - brass gold

### PREVERNICIATI *PREPAINTED*

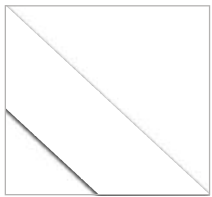

**M3** - polished white

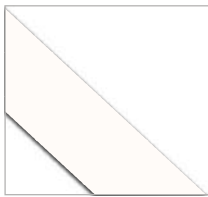

**M4** - matt white



**U6** - inox



**U8** - brushed bronze

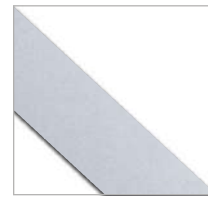

**U5** - alumatt

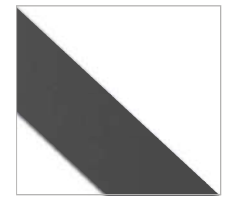

**U9** - anthracite



**L1** - polished black



**L2** - matt black

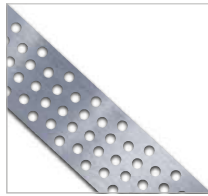

**Wind**  
Disponibile per tutte  
le finiture Available for  
all finishes

*Tutti i profili sono forniti di film protettivo  
All profiles are supplied with a protective film*

## Specifiche *Technical details*

### ALLUMINIO MICROFORATO

Con aperture rotonde e sfalsate, il metallo perforato è un materiale industriale utilizzato in numerosi progetti di interni. Con la sua trasparenza, il materiale funziona bene con altri elementi e aiuta a creare profondità. È apprezzato soprattutto per la sua qualità grafica e l'effetto ottico che produce quando viene stratificato.

### ALUMINIUM PERFORATED

With round and staggered openings, perforated metal is an industrial material that is used in a number of interior projects. With its transparency, the material works well with other elements and helps create depth. It is mostly appreciated for its graphic quality and the optical effect it produces when layered.

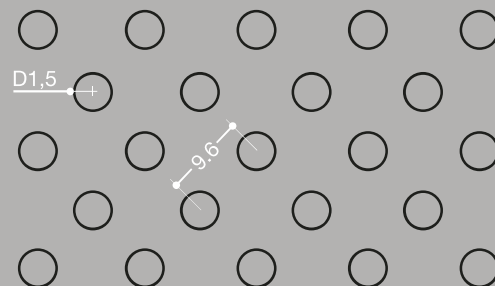

# TRONCATORI

## CUTTING MACHINES

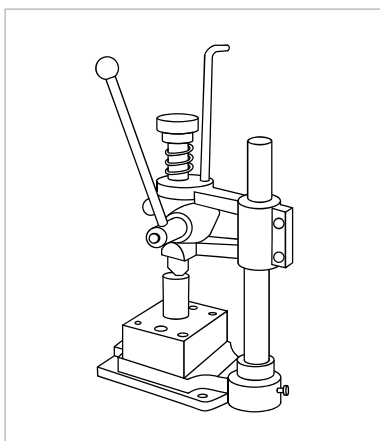

### FBS 7700

Troncatore manuale per bandelle  
*Manual cutting machine for strips.*

Comprendivo di uno stampo a scelta tra  
*Including a mould to choose from :*

**FBS 7701** (per troncatura profilo *for cutting profile* FBS 8006 e 2106 e R3)

**FBS 7704** (per troncatura profilo *for cutting profile* FBS 8008 90° e R4)

**FBS 7702** (per troncatura profilo *for cutting profile* FBS 8010 90° e R5)

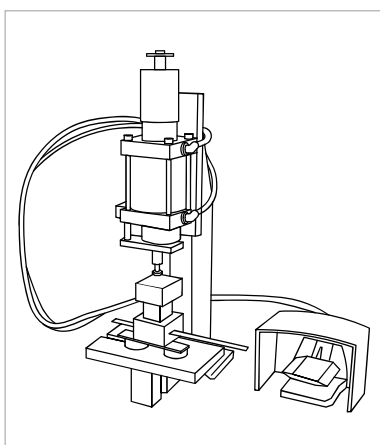

### FBS 7800

Troncatore pneumatico a un pistone per bandelle  
*Pneumatic cutting machine with a piston for strips.*

Comprendivo di uno stampo a scelta tra  
*Including a mould to choose from :*

**FBS 7701** (per troncatura profilo *for cutting profile* FBS 8006, 2106, 7106 e R3)

**FBS 7704** (per troncatura profilo *for cutting profile* FBS 8008 90° e R4)

**FBS 7702** (per troncatura profilo *for cutting profile* FBS 8010, 2110 90° e R5)

### Stampi per *moulds for* FBS 8006, FBS 8008, FBS 8010, FBS 2106

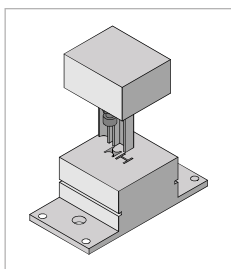

**FBS 7701**  
 R3 - 90°

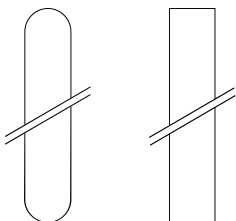

**Raggio a 3 mm**   **Taglio a 90°**  
*3 mm radius*   *90° cut*

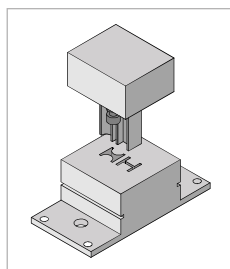

**FBS 7704**  
 R4 - 90°

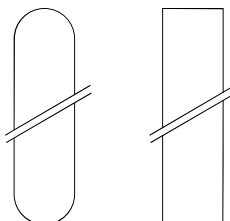

**Raggio a 4 mm**   **Taglio a 90°**  
*4 mm radius*   *90° cut*

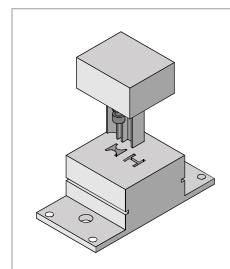

**FBS 7702**  
 R5 - 90°

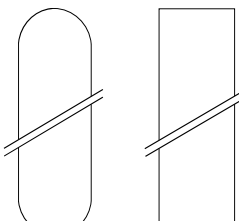

**Raggio a 5 mm**   **Taglio a 90°**  
*5 mm radius*   *90° cut*

ART DIRECTION  
Gio Tiroto / giotiroto.it

PHOTO CREDITS  
Federico Villa / federicovilla.it

IMAGE PRODUCTION  
Buildest / buildest.it

PRINT  
Furlan Grafica / furlangrafica.com

COPYRIGHT 2021  
FBSProfilati srl

SCOPRI TUTTI I NOSTRI PRODOTTI SU  
*DISCOVER OUR FULL PRODUCT RANGE AT*

**fbsprofilati.it**





Il presente catalogo è di proprietà  
di FBSProfilati S.r.l. Tutti i diritti riservati.  
Sono vietate riproduzione e alterazione.  
Illustrazioni e dati contenuti in questo catalogo  
hanno valore indicativo. Per una corretta installazione  
fare riferimento ai manuali.

*This catalogue is property of FBSProfilati S.r.l.*

*All rights reserved.*

*Reproduction and Alterations are forbidden.*

*All illustrations and information in this catalogue  
are indicative. For a correct installation please refer  
to the assembly instruction manuals.*

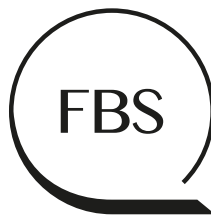

**PROFILATI ITALIANI**



**FBSProfilati srl**

**Via Edison, 251**  
20019 Settimo Milanese MI - Italia

phone: +39 024564768 | +39 0248916411

[info@fbsprofilati.it](mailto:info@fbsprofilati.it)

[fbsprofilati.it](http://fbsprofilati.it)