

ALUGLASS *Double glazing profiles*



**FBS Profilati srl, fondata nel 1999
dalla seconda generazione
imprenditoriale della nostra famiglia,
è un'azienda dinamica che trae la sua
essenza dal concept del "MADE IN ITALY"
tramandato attraverso l'esperienza
delle sue figure storiche che dal 1964
si dedicano con entusiasmo alla
progettazione e produzione di profili
decorativi in alluminio e serrandine.
Nella nostra sede di Settimo Milanese, che
si sviluppa su una superficie complessiva
di 5000 m², creiamo prodotti sempre
all'avanguardia e al passo con le più
moderne tendenze del mondo del design
per arredamento di interni a partire
da materie prime di qualità eccellente.**

FBS Profilati srl, founded in 1999 by the second managerial generation of our family, is a dynamic company that draws its essence from the concept of "MADE IN ITALY" handed down through the experience of senior figures who have enthusiastically committed to designing and manufacturing aluminium decorative profiles and tambour doors since 1964.

In our headquarters in Settimo Milanese, stretching over a 5000m² area, we create forefront and contemporary up-to-date products with modern furniture design trends, exclusively using excellent raw materials.



ALUGLASS

PROFILI DECORATIVI PER VETRO CAMERA

Da oltre 40 anni proponiamo la nostra linea di profili decorativi in alluminio ALUGLASS, compendio di tutto ciò che rappresenta la nostra azienda: la padronanza impeccabile della tecnica e la costante ricerca del bello che conferisce un tocco personalizzabile a finestre e vetrate isolanti trasformandole così in veri pezzi unici. Le nostre barre profilate a freddo, leggere ma al contempo resistenti, sono sempre tagliate a 90° e grazie ai molteplici accessori si ottengono originali motivi senza l'utilizzo di macchinari. Abbinare ai creativi inserti ed accessori e declinate in svariate sfumature di colore, si abbinano perfettamente ai diversi stili abitativi.

PROFILI DECORATIVI PER VETRO PIANO (ASTRAGAL bars)

La nostra gamma di profili autoadesivi permette di riprodurre lo stesso look anche su vetro piano, pareti divisorie in vetro o su materiali diversi come boiserie, marmo, carta da parati e specchi. E' possibile così porre l'accento su un tono minimalista e contemporaneo oppure classico e tradizionale. Le possibilità e combinazioni sono davvero infinite. Esattamente come la collezione per vetro camera, anche in questo caso la preparazione e assemblaggio dei profili con i relativi giunti è semplice e non necessita di attrezzature complesse.

DECORATIVE PROFILES FOR DOUBLE GLAZING

For over 40 years we have been offering our line of ALUGLASS decorative aluminium profiles, a compendium of everything that our company represents: the impeccable mastery of the technique and the constant search for beauty that gives a customizable touch to windows and insulating glass, thus transforming them into truly unique pieces. Our roll formed aluminium bars, light but resistant at the same time, are always cut at 90° and thanks to the many accessories, original motifs are obtained without the use of machinery. Combined with creative inserts and accessories and available in various shades of colour, they perfectly match different living styles.

DECORATIVE PROFILES FOR SINGLE GLASS (ASTRAGAL bars)

Our range of self-adhesive profiles allows you to reproduce the same look even on single glass partition walls or on different materials such as boiserie, marble, wallpaper and mirrors. It is thus possible to place the accent on a minimalist and contemporary or classic and traditional tone. The possibilities and combinations are truly endless. Just like the collection for double glazing, also in this case the preparation and assembly of the profiles with the specific joints is simple and does not require complex equipment.



lavorazioni su misura
custom made products



profilatura a freddo
roll formed profiling



progettazione
di nuovi prodotti
*development of
new products*



materiali riciclabili
recyclable materials

Profili per Vetro Camera

Double Glazing Profiles

pag. 7

FBS 1323 WAY

pag. 9

FBS 1322

pag. 20

FBS 1062

pag. 26

FBS 1133

pag. 29

FBS 1251

pag. 32

FBS 2218

pag. 33

Profili Autoadesivi per Vetro Piano

Self-adhesive Single Glass Profiles

pag. 35

FBS 1324 WAY

pag. 39

FBS 1193

pag. 40

FBS 918

pag. 41

FBS 2038

pag. 43

FBS 2040

pag. 43

FBS 2041

pag. 43

Finiture

Finishes

pag. 44

Specifiche Tecniche

Technical Details

pag. 48

Calandra Manuale

Manual Bending Machine

pag. 49



PROFILI DECORATIVI PER VETRO CAMERA

DECORATIVE PROFILES FOR DOUBLE GLAZING



Sin dalla loro origine le nostre griglie decorative per vetro camera si sono proposte come l'alternativa ecologica più valida al piombo, materiale tradizionalmente utilizzato per ottenere l'effetto "stile inglese".

I profili decorativi vengono fissati ai distanziatori attraverso appositi terminali, possono essere montati in senso verticale od orizzontale, e poi incapsulati all'interno del doppio vetro rimanendo così completamente protetti da agenti esterni e intemperie.

Le finiture di altissima qualità dell'alluminio, sia anodizzate che pre-verniciate, garantiscono la lunga durata del prodotto.

Since their origin, our decorative grids for double glazing have been proposed as the most valid ecological alternative to lead, a material traditionally used to obtain the "English style" effect.

The decorative profiles are fixed to the spacers through special terminals, they can be mounted vertically or horizontally, and then encapsulated inside the double glass, thus remaining completely protected from external agents and bad weather.

The high quality aluminium finishes, both anodized and pre-painted, guarantee the long life of the product.

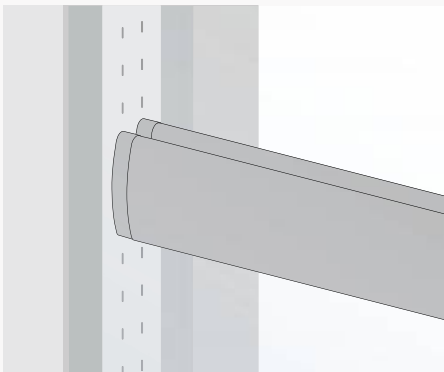

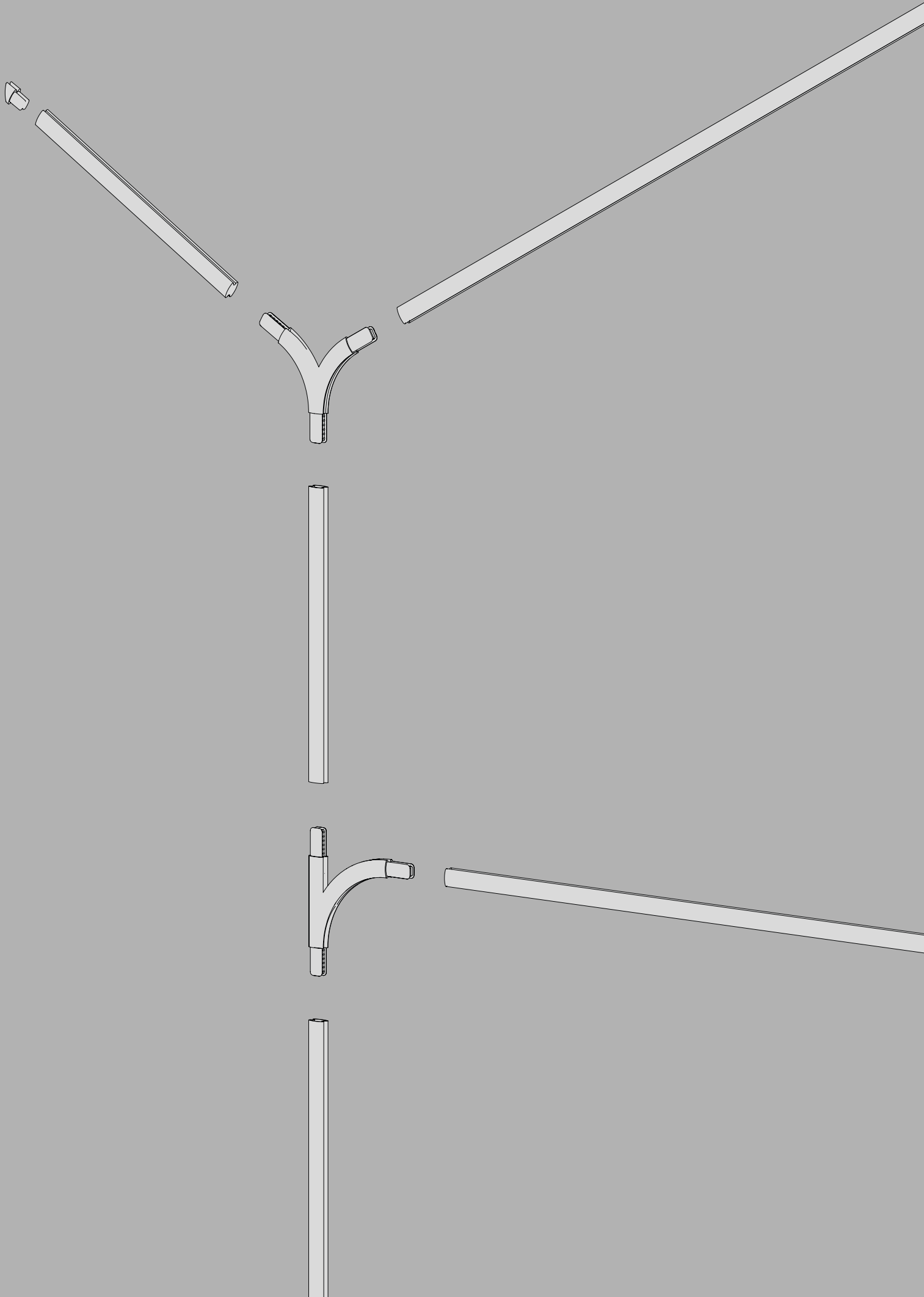

FBS 1323 WAY

design Gio Tiroto

Una collezione contemporanea di sistemi decorativi per vetro camera, giunti e accessori che consentono abbinamenti sorprendenti dalle linee essenziali e al contempo sinuose.

A contemporary collection of decorative systems for double glazing, joints and accessories that allow surprising combinations with essential yet sinuous lines.

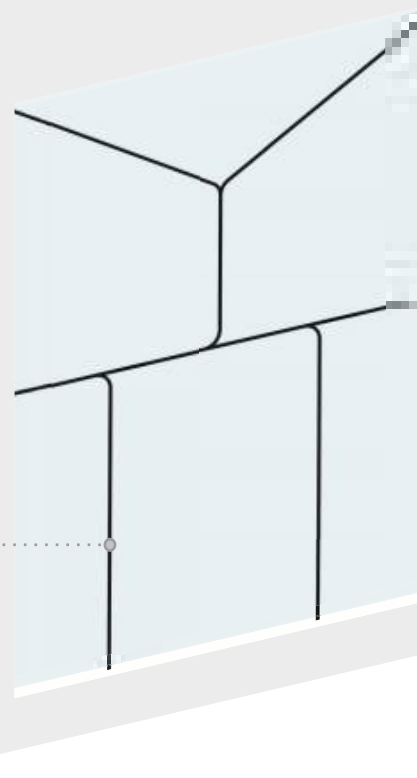
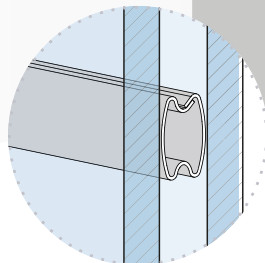

Profilo *Aluminium Profile*

misure in mm
dimensions in mm

CODICE
CODE

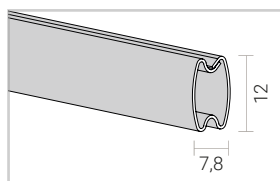

FBS 1323

● Plastica riciclata e riciclabile
Recycled and recyclable



● 100% Alluminio
100% Aluminium



Accessori *Accessories*

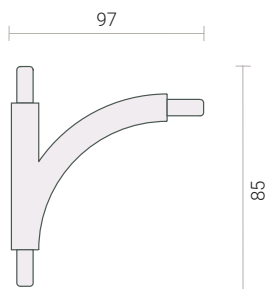

FBS 9523

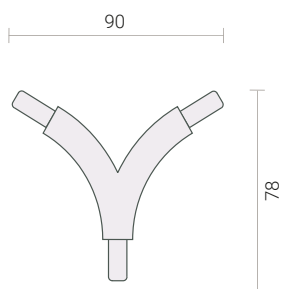

FBS 9524

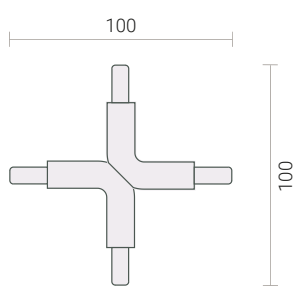

FBS 9525

Terminali *Terminals*

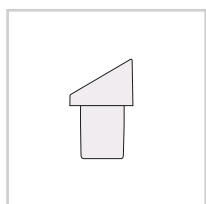

FBS 9531 - 30°/60°

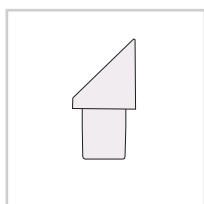

FBS 9532 - 45°

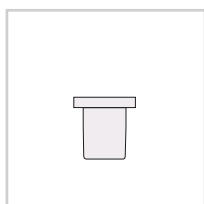

FBS 9530 - 90°







FBS 1323 WAY

design Gio Tiroto

I tre terminali con diverse gradazioni permettono una veloce e facile lavorazione e preparazione delle griglie grazie al taglio a 90° del profilo in alluminio.

The three terminals with different inclinations allow quick and easy processing and preparation of the grids thanks to the 90° cut of the aluminium profile.

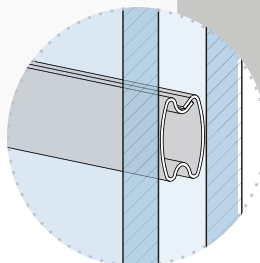

Terminali *Terminals*

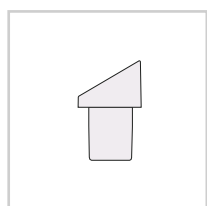

FBS 9531 - 30°/60°

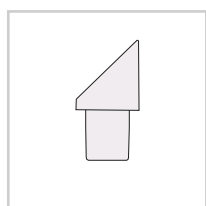

FBS 9532 - 45°

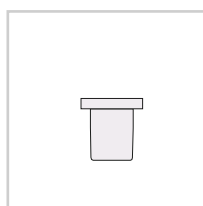

FBS 9530 - 90°

○ Plastica riciclata e riciclabile
Recycled and recyclable



○ 100% Alluminio
100% Aluminium



ISTRUZIONI DI MONTAGGIO *ASSEMBLY INSTRUCTIONS*

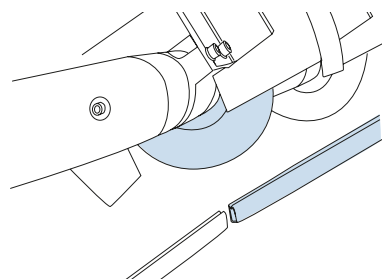

1. Tagliare a 90° i profili nella lunghezza desiderata.

Cut the profiles at a 90-degree angle to the desired length.

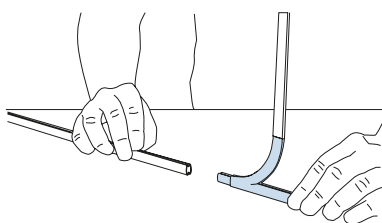

2. Inserire i giunti o decori per creare il disegno prescelto.

Add the necessary joints or decorations to create your desired design.

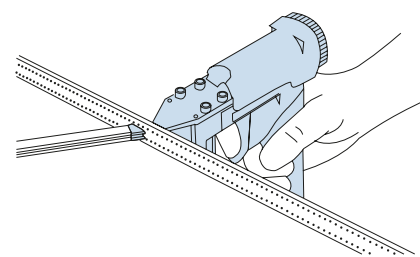

3. Una volta assemblate ai relativi giunti, le griglie sono inserite nel vetro camera e fissate ai distanziatori tramite graffette.

Once assembled to the specific joints, the grilles are inserted into the double glazing and fixed to the spacers using staples.





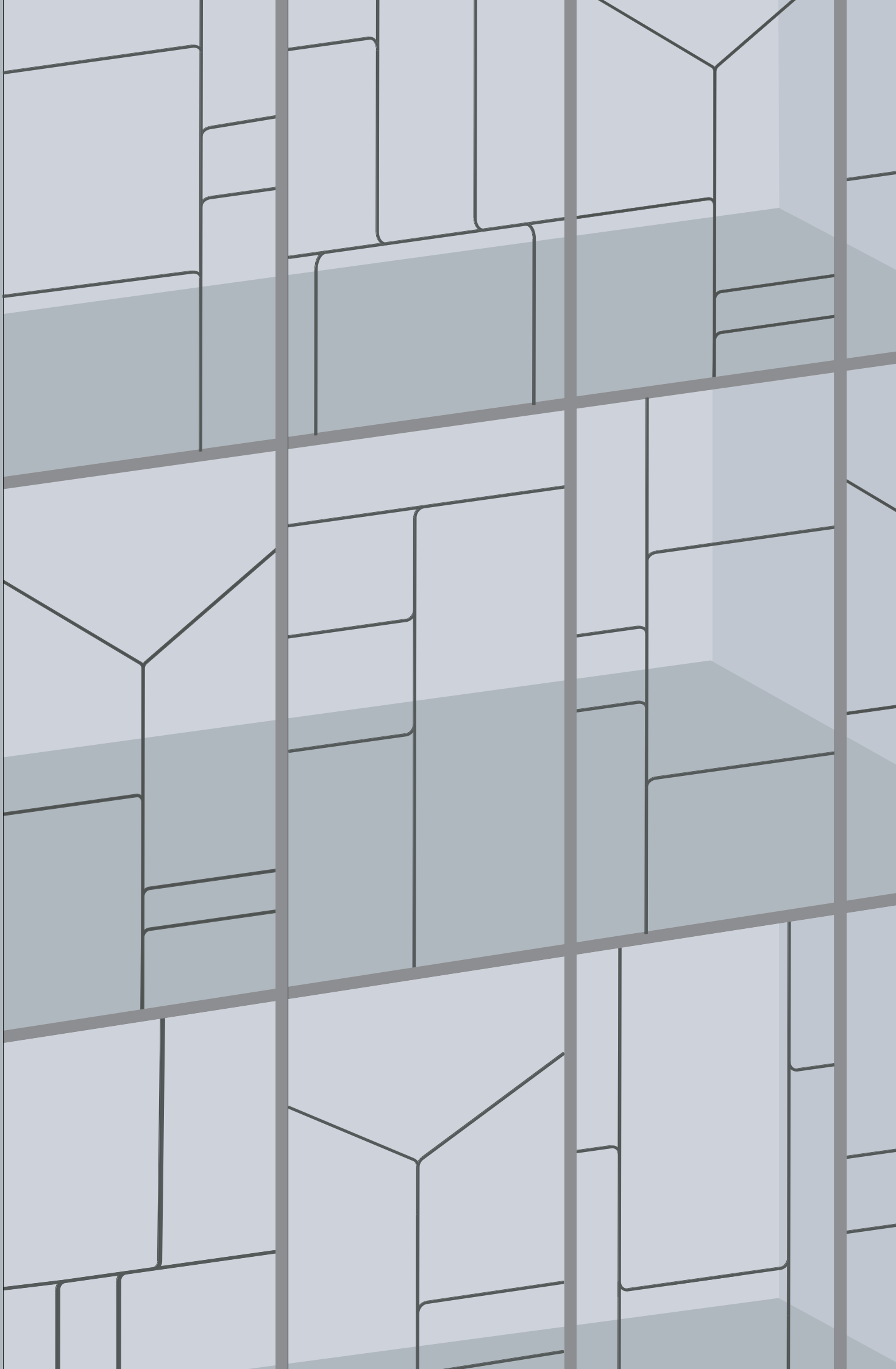

INFINITE COMBINAZIONI

ENDLESS COMBINATIONS

Un giunto che crea molteplici direzioni e infinite combinazioni. La finestra diventa una cornice naturale che fa da filtro tra Uomo e Natura, tra interno ed esterno, tra luce e decorazione.

A joint that creates multiple directions and infinite combinations. The window becomes a natural frame that acts as a filter between Man and Nature, between inside and outside, between light and decoration.

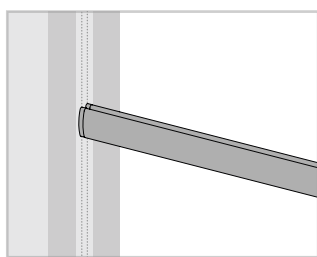

FBS 9530 - 90°

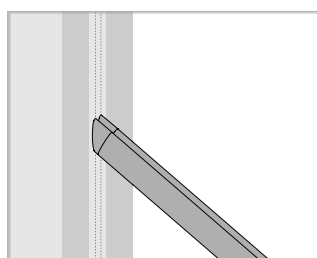
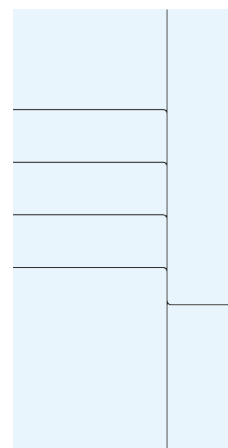
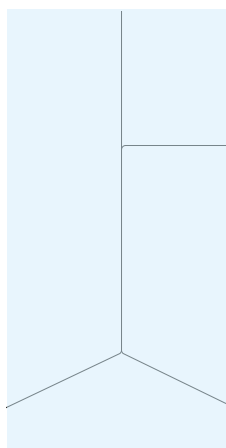
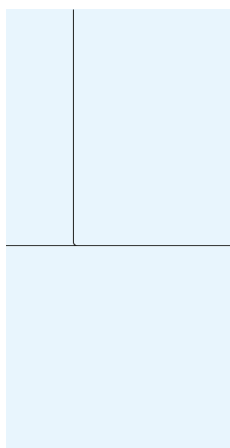

FBS 9532 - 45°

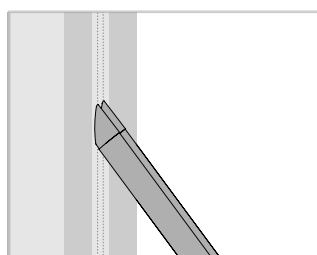
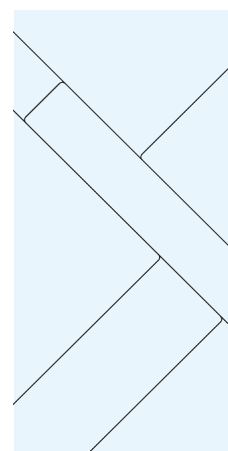
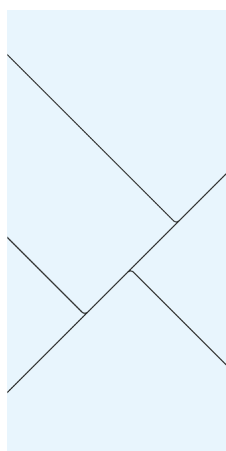
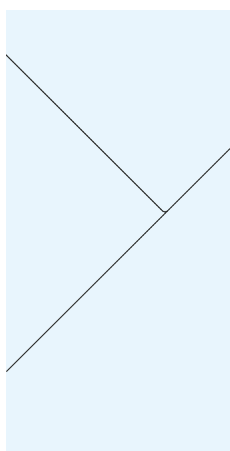

FBS 9531 - 30°/60°

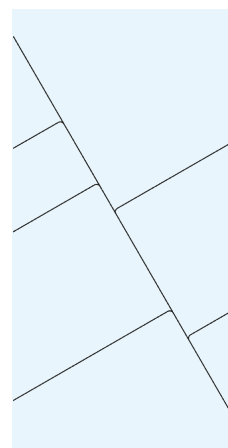
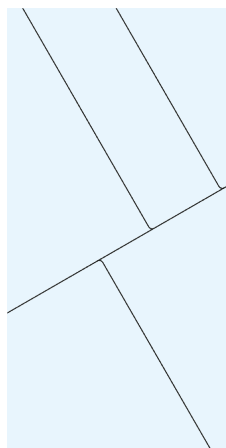
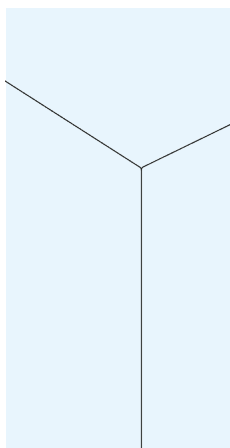





FBS 1322

PROFILO OVALE

OVAL SHAPE PROFILE

Un profilo sottile adatto per canaline a partire da mm 6 a cui si affiancano accessori e decori dal disegno essenziale e geometrico.

A thin profile suitable for spacers starting from 6 mm which is accompanied by accessories and decorations with an essential and geometric design.

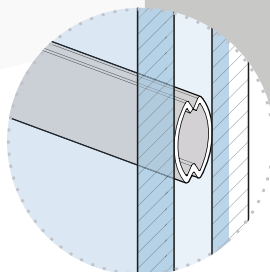

Profilo Aluminium Profile

misure in mm
dimensions in mm

CODICE
CODE

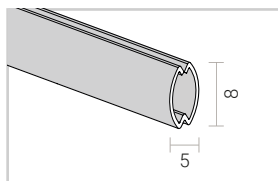

FBS 1322

○ Plastica riciclata e riciclabile
Recycled and recyclable



● 100% Alluminio
100% Aluminium



Decorì Decors

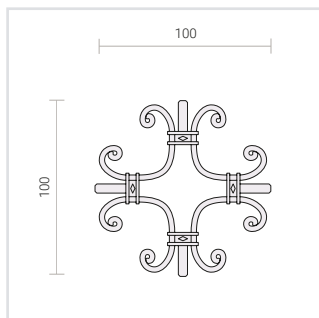

FBS 9016

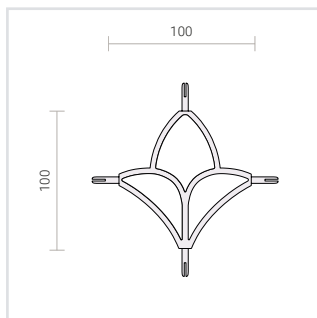

FBS 9019

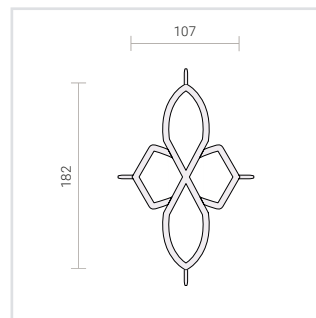

FBS 9020

FBS 1322

PROFILO OVALE

OVAL SHAPE PROFILE

Una linea di inserti ispirati da tradizioni e culture lontane.

I processi di galvanica e metallizzazione garantiscono il perfetto abbinamento tra le finiture anodizzate dei profili in alluminio e quelle dei decori.

A line of inserts inspired by distant traditions and cultures. The galvanic and metallization processes guarantee the perfect match between the anodized finishes of the aluminium profiles and those of the decorations.

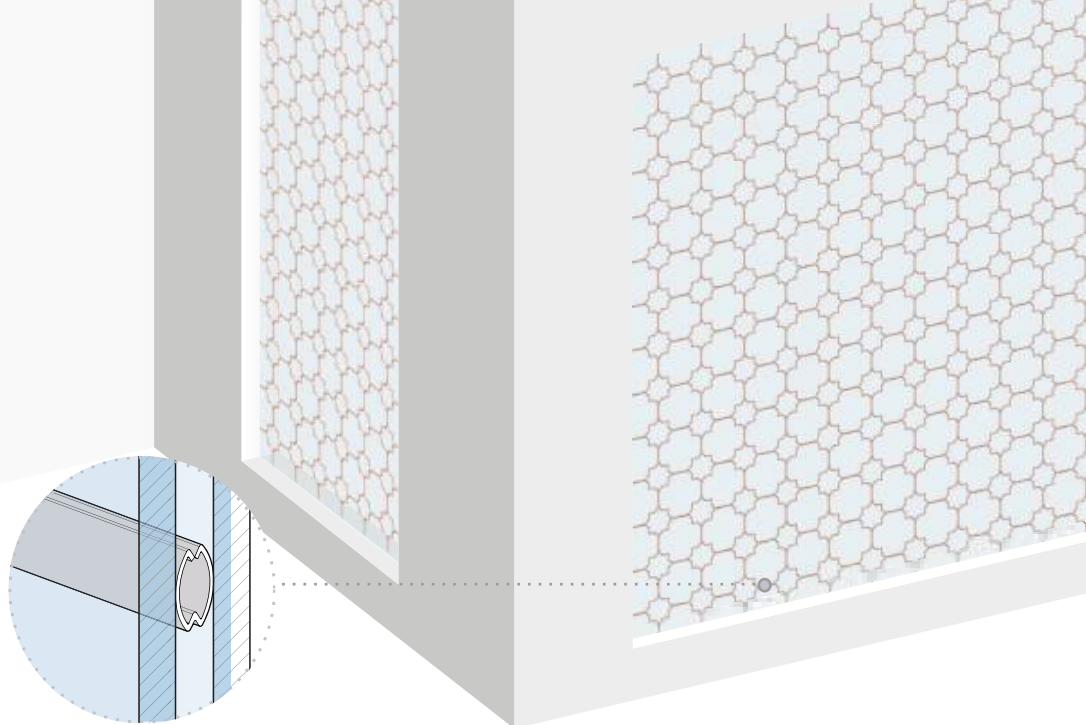

Profilo Aluminium Profile

misure in mm
dimensions in mm

CODICE
CODE

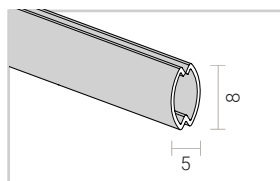

FBS 1322

○ Plastica riciclata e riciclabile
Recycled and recyclable



○ 100% Alluminio
100% Aluminium



Decorì Decors

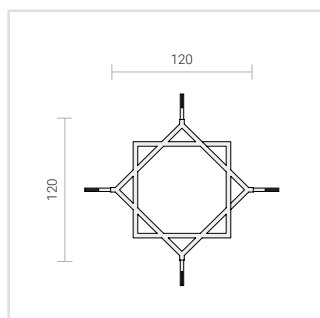

FBS 9021 - 120

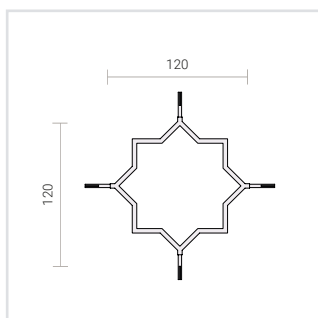

FBS 9023 - 120

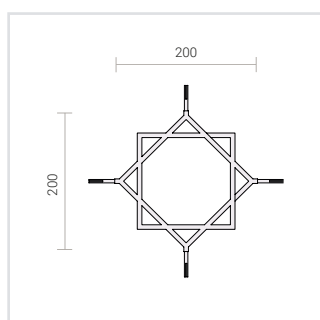

FBS 9022 - 200

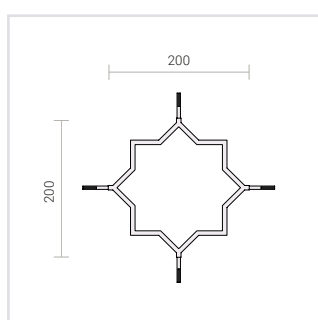

FBS 9024 - 200

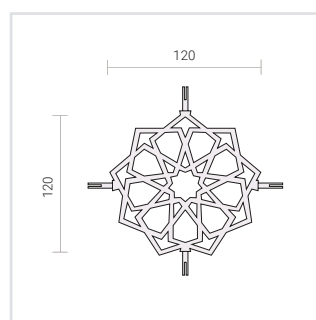

FBS 9027

FBS 1322

PROFILO OVALE

OVAL SHAPE PROFILE

I semplici giunti in ABS metallizzati nel colore della barra in alluminio consentono la creazione di intricati disegni senza l'utilizzo di complesse attrezzature.

The simple ABS joints metallised in the same color as the aluminium bar allow for the creation of intricate designs without the use of complex equipment.

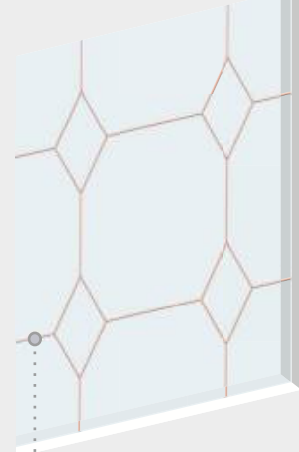
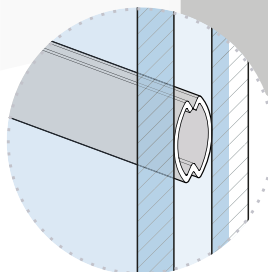

Profilo Aluminium Profile

misure in mm
dimensions in mm

CODICE
CODE

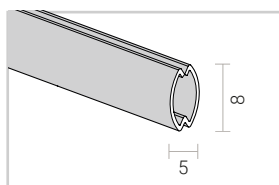

FBS 1322

Plastica riciclata e riciclabile
Recycled and recyclable



100% Alluminio
100% Aluminium



Accessori a innesto Connectors

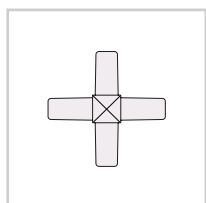

FBS 9012

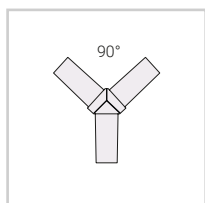

FBS 9013

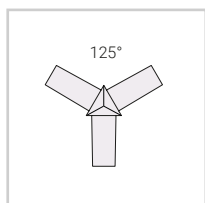

FBS 9017

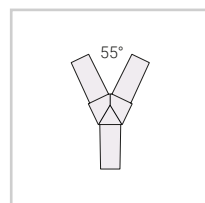

FBS 9018

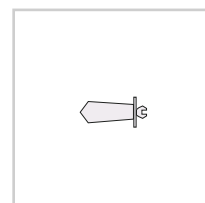

FBS 9014

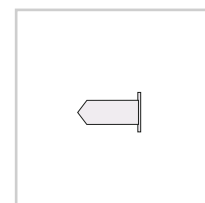

FBS 9015

OPZIONI DI FISSAGGIO ALLA CANALINA SPACER BAR FIXING OPTIONS

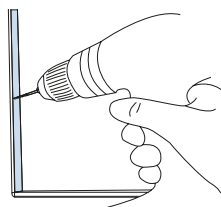

A) FBS 9014
Praticando un piccolo foro nella parte interna della canalina è possibile inserire a pressione il terminale di fissaggio.

By making a small hole in the internal part of the spacer bar and inserting the terminal's pin, it is possible to firmly secure the profile bar in place.

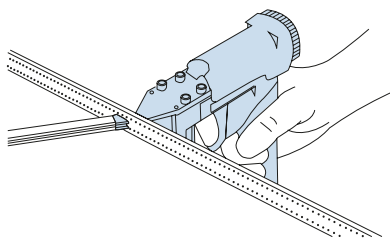

B) FBS 9015
Il profilo con inserito il relativo terminale piatto viene fissato alla canalina con delle graffette.

The profile is secured to the spacer bar using staples or nails.

FBS 1322

PROFILO OVALE

OVAL SHAPE PROFILE

Le clips in alluminio sono un'opzione che consente il rivestimento dei giunti in ABS per chi volesse un risultato con solo alluminio.

The aluminium clips are an option that allows the ABS joints to be covered in aluminium for those who prefer a more even final look.

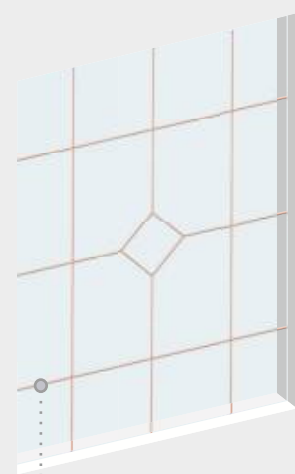
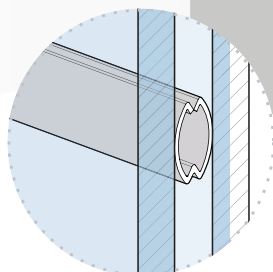

Profilo Aluminium Profile

misure in mm
dimensions in mm

CODICE
CODE

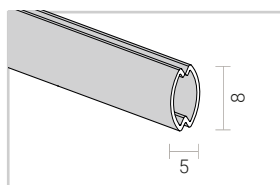

FBS 1322

○ Plastica riciclata e riciclabile
Recycled and recyclable



● 100% Alluminio
100% Aluminium



Accessori a clip Clips

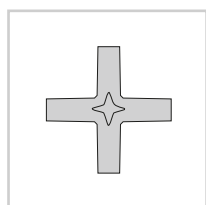

FBS 9336

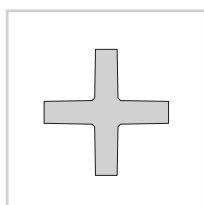

FBS 9324

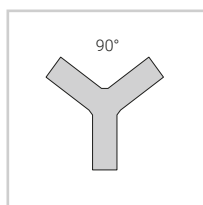

FBS 9337

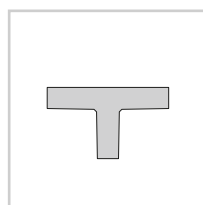

FBS 9338

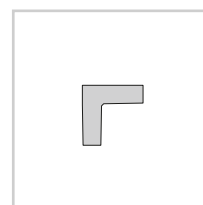

FBS 9339

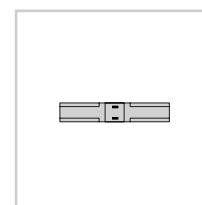

FBS 9325

ISTRUZIONI DI MONTAGGIO ASSEMBLY INSTRUCTIONS

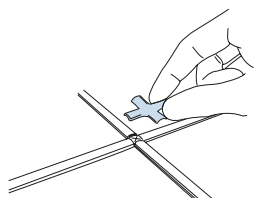

1. Dopo aver tagliato i profili, unirli tramite gli appositi giunti.

After cutting the profiles, proceed with the assembly with the specific joints.

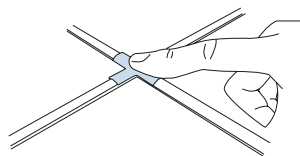

2. Posizionare l'accessorio a clip e fissarlo esercitando una leggera pressione.

Position the clip accessory and fix it by applying a light pressure.

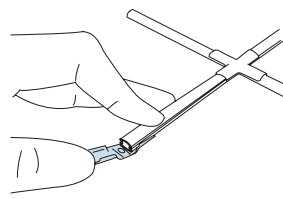

3. Posizionare la fascetta FBS 9325 alle estremità del profilo.

Position the bend accessory FBS 9325 at both ends of the profile.

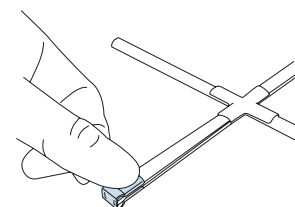

4. Piegare entrambe le estremità facendole aderire al profilo.

Bend both ends so that they adhere tightly to the profile.





FBS 1062

PROFILO TONDO

ROUND SHAPE PROFILE

Il nostro primo e storico progetto di decorazione industriale per vetro, con l'originale decoro "ferro battuto". Il più imitato nel settore vetro camera.

Our first and historical industrial decoration project for glass, with the original "wrought iron" decoration. The most imitated in the double glazing sector.

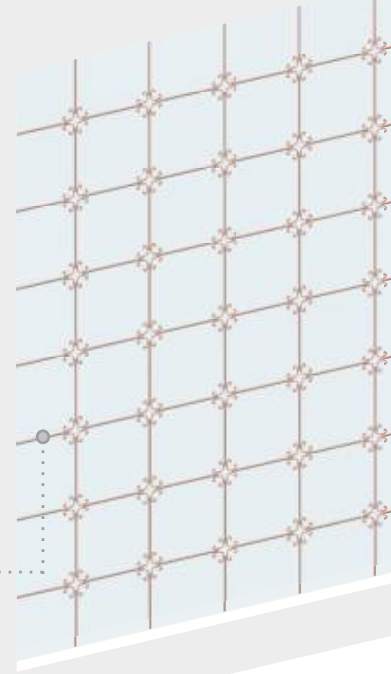
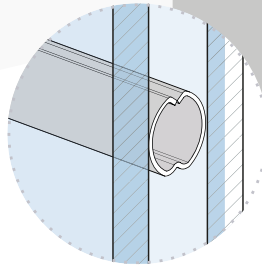

Profilo Aluminium Profile

misure in mm
dimensions in mm

CODICE
CODE

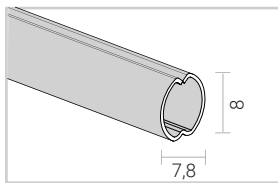

FBS 1062

○ Plastica riciclata e riciclabile
Recycled and recyclable



● 100% Alluminio
100% Aluminium



Decori Decors

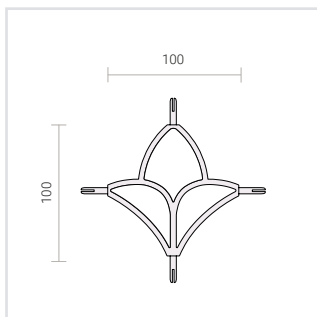

FBS 9163

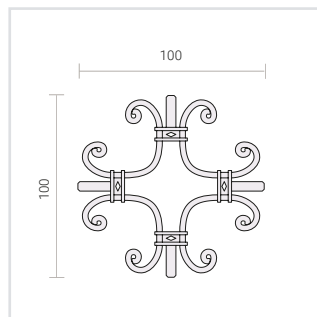

FBS 9162

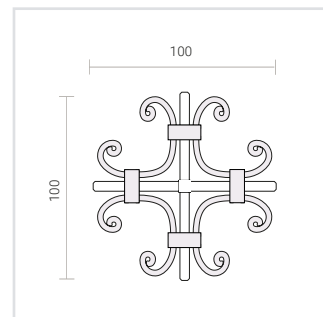

FBS 9061

FBS 1062

PROFILO TONDO

ROUND SHAPE PROFILE

I raccordi a raggiera permettono di realizzare parti curve che conferiscono armonia e proporzioni dal gusto classico.

The radial connections allow to create curved parts that give harmony and proportions with a classic taste.

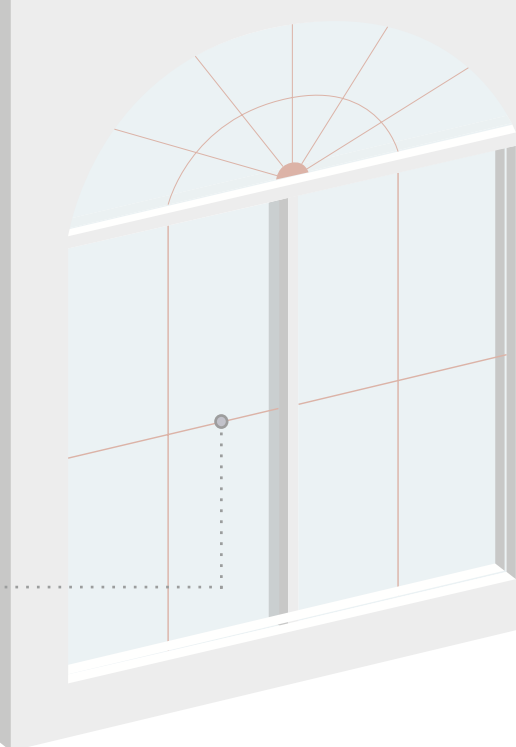
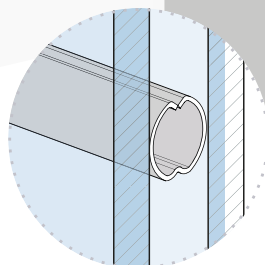

Profilo Aluminium Profile

misure in mm
dimensions in mm

CODICE
CODE

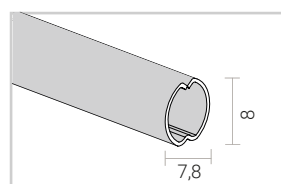

FBS 1062

○ Plastica riciclata e riciclabile
Recycled and recyclable



○ 100% Alluminio
100% Aluminium



Accessori Accessories

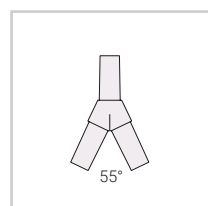

FBS 9068

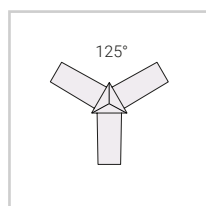

FBS 9067

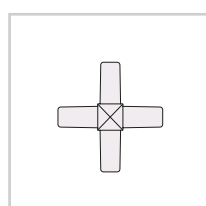

FBS 9062

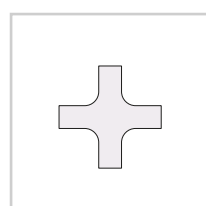

FBS 9306

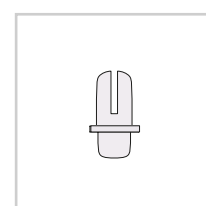

FBS 9064

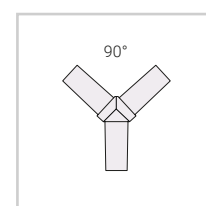

FBS 9065

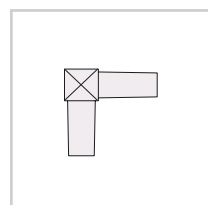

FBS 9066

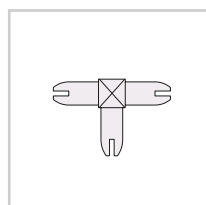

FBS 9060

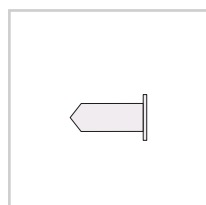

FBS 9073

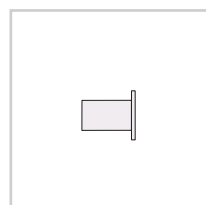

FBS 9070

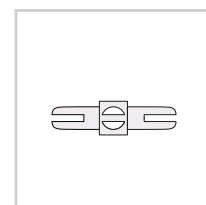

FBS 9264

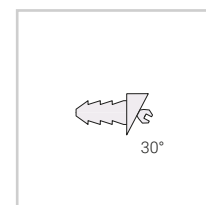

FBS 9263 - 30°/60°

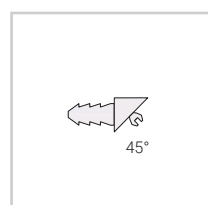

FBS 9262

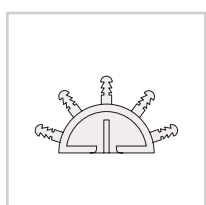

FBS 9266

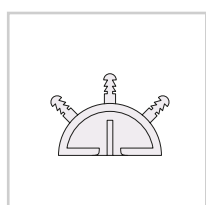

FBS 9265

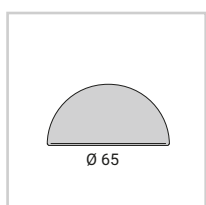

FBS 9362

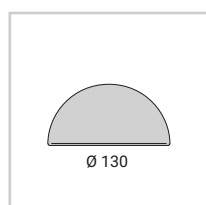

FBS 9363



FBS 1133

PROFILO A "H"

"H" SHAPE PROFILE

L'evoluzione dalle vetrate a cattedrale a piombo è rappresentata da questa famiglia di profili e accessori che possono accogliere altri inserti in vetro con spessore 3 mm.

The evolution from stained glass is represented by this family of profiles and accessories that can accommodate other glass inserts with a thickness of 3 mm.

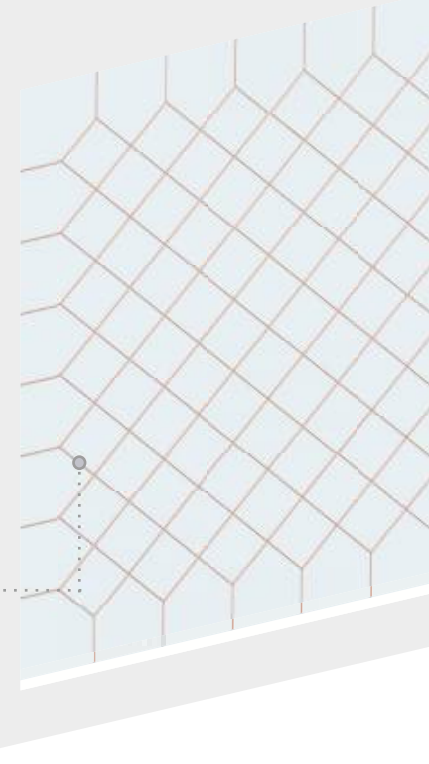
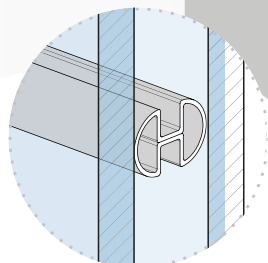

Profilo Aluminium Profile

misure in mm
dimensions in mm

CODICE
CODE

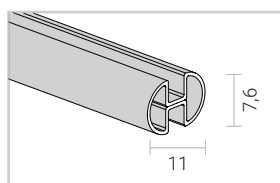

FBS 1133

○ Plastica riciclata e riciclabile
Recycled and recyclable



○ 100% Alluminio
100% Aluminium



Accessori Accessories

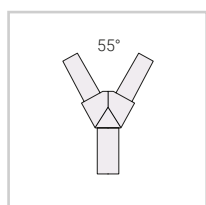

FBS 9035

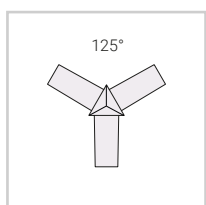

FBS 9036

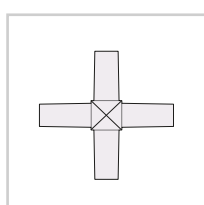

FBS 9037

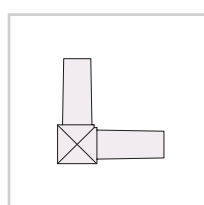

FBS 9038

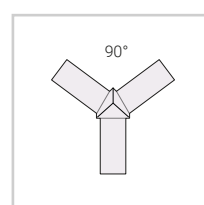

FBS 9133

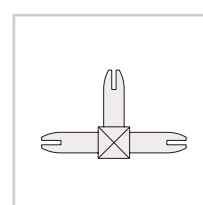

FBS 9134

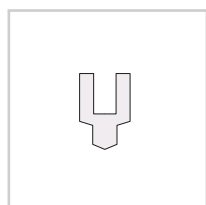

FBS 9034





FBS 1251
PROFILO PIATTO
FLAT SHAPE PROFILE

L'originale profilo "Georgian" che consente di replicare in chiave più moderna le classiche atmosfere Vittoriane in finestre e porte di ingresso a vetri.

The original "Georgian" profile that allows you to replicate the classic Victorian atmospheres in windows and glass entrance doors in a more modern key.

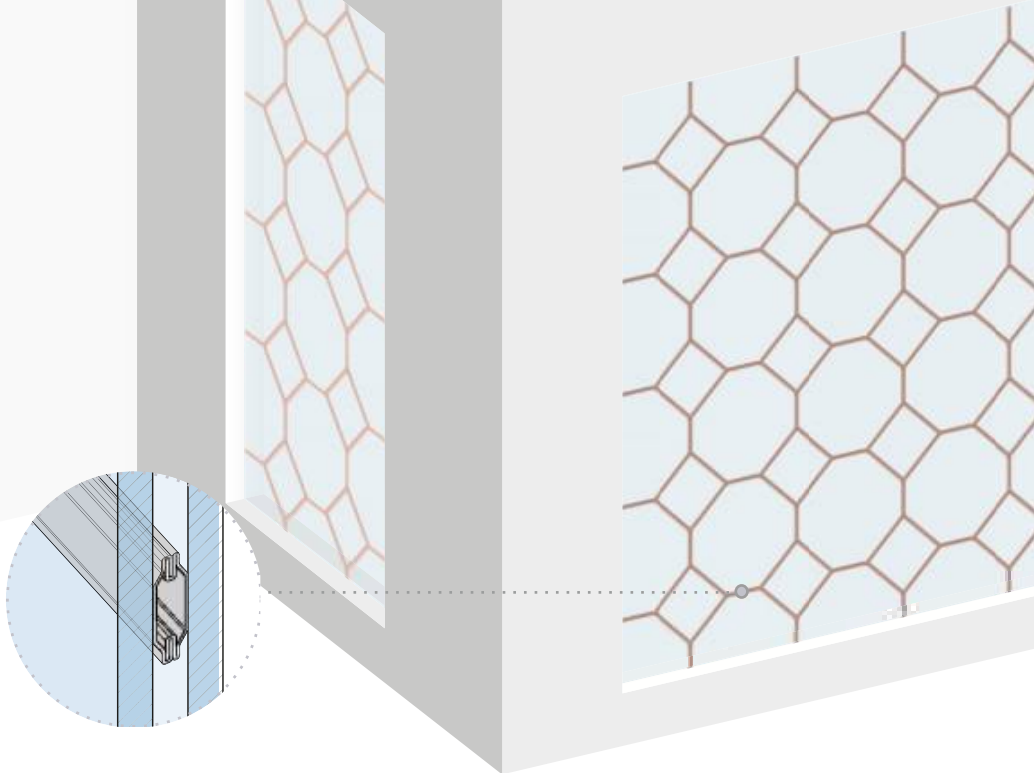

Profilo Aluminium Profile

misure in mm
 dimensions in mm

CODICE
 CODE

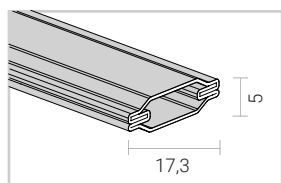

FBS 1251

○ Plastica riciclata e riciclabile
 Recycled and recyclable



○ 100% Alluminio
 100% Aluminium



Decoro Decor

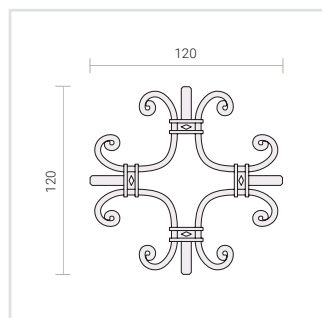

FBS 9247

Accessori Accessories

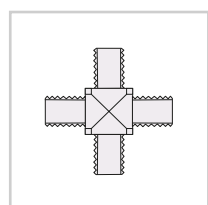

FBS 9255

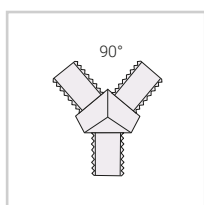

FBS 9261

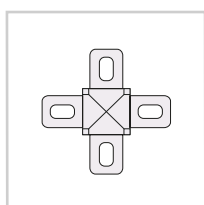

FBS 9251

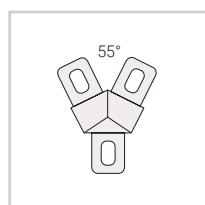

FBS 9252

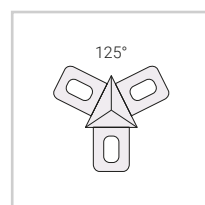

FBS 9253

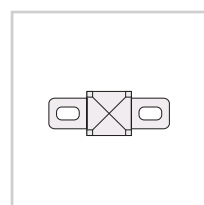

FBS 9250

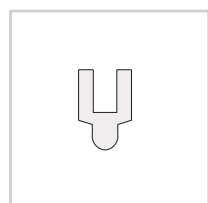

FBS 9258

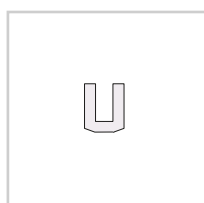

FBS 9254

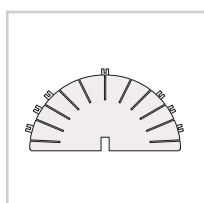

FBS 9249

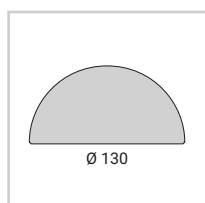

FBS 9351

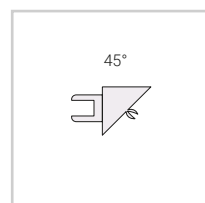

FBS 9259

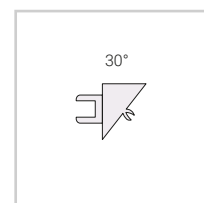

FBS 9260 - 30°/60°

FBS 2218

PROFILO PIATTO

FLAT SHAPE PROFILE

Lo stile inglese nella sua quintessenza e purezza di linee.

Questo profilo replica le tradizionali lavorazioni delle finestre in legno e vetro.

The English style in its quintessence and purity of lines.

This profile replicates traditional wood and glass window manufacturing.

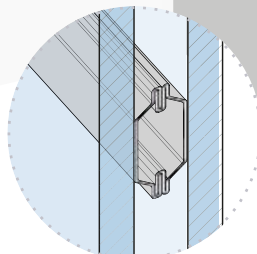

Profilo Aluminium Profile

misure in mm
dimensions in mm

CODICE
CODE

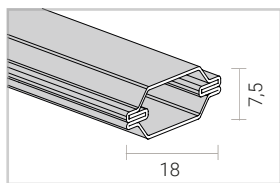

FBS 2218

○ Plastica riciclata e riciclabile
Recycled and recyclable



○ 100% Alluminio
100% Aluminium



Accessori Accessories

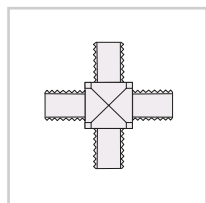

FBS 9218

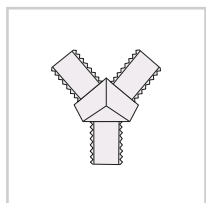

FBS 9219

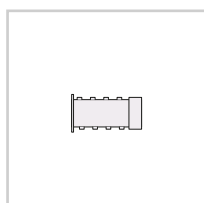

FBS 9220

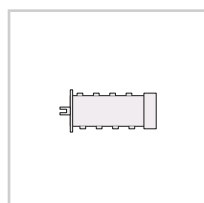

FBS 9221



PROFILI DECORATIVI AUTOADESIVI PER VETRO PIANO (ASTRAGAL bars)

*SELF-ADHESIVE DECORATIVE PROFILES FOR FLAT GLASS
(ASTRAGAL bars)*

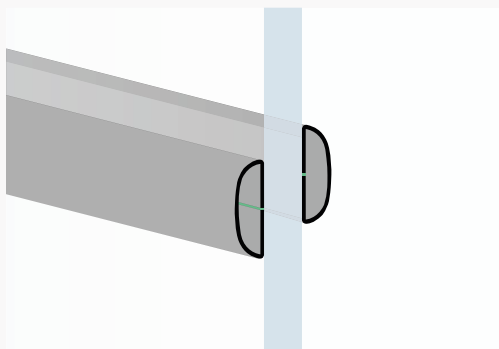

La moderna rivisitazione delle tradizionali finestre “stile inglese” è possibile grazie all’applicazione dei nostri profili, forniti con biadesivo, su entrambi i lati del vetro piano. Il risultato è di grande effetto, il vetro risulta ripartito in diverse sezioni con tutti i vantaggi che derivano da questa facile e agevole applicazione. Ideali per creare motivi decorativi anche su diversi materiali e superfici come specchi, boiserie, carta da parati, pannelli in genere. Il noto e affidabile nastro adesivo originale Tesa è estremamente robusto e fornisce una presa sicura per tutta la vita dei prodotti.

The modern reinterpretation of the traditional “English style” windows is possible thanks to the application of our profiles, supplied with double-sided adhesive, on both sides of the flat glass.

The result is impressive, the glass is divided into different sections with all the advantages that derive from this simple and easy application.

Ideal for creating decorative motifs even on different materials and surfaces such as mirrors, boiserie, wallpaper, panels in general.

The well-known and trusted Tesa Original adhesive tape is extremely robust and provides a secure hold for the life-time of the products.





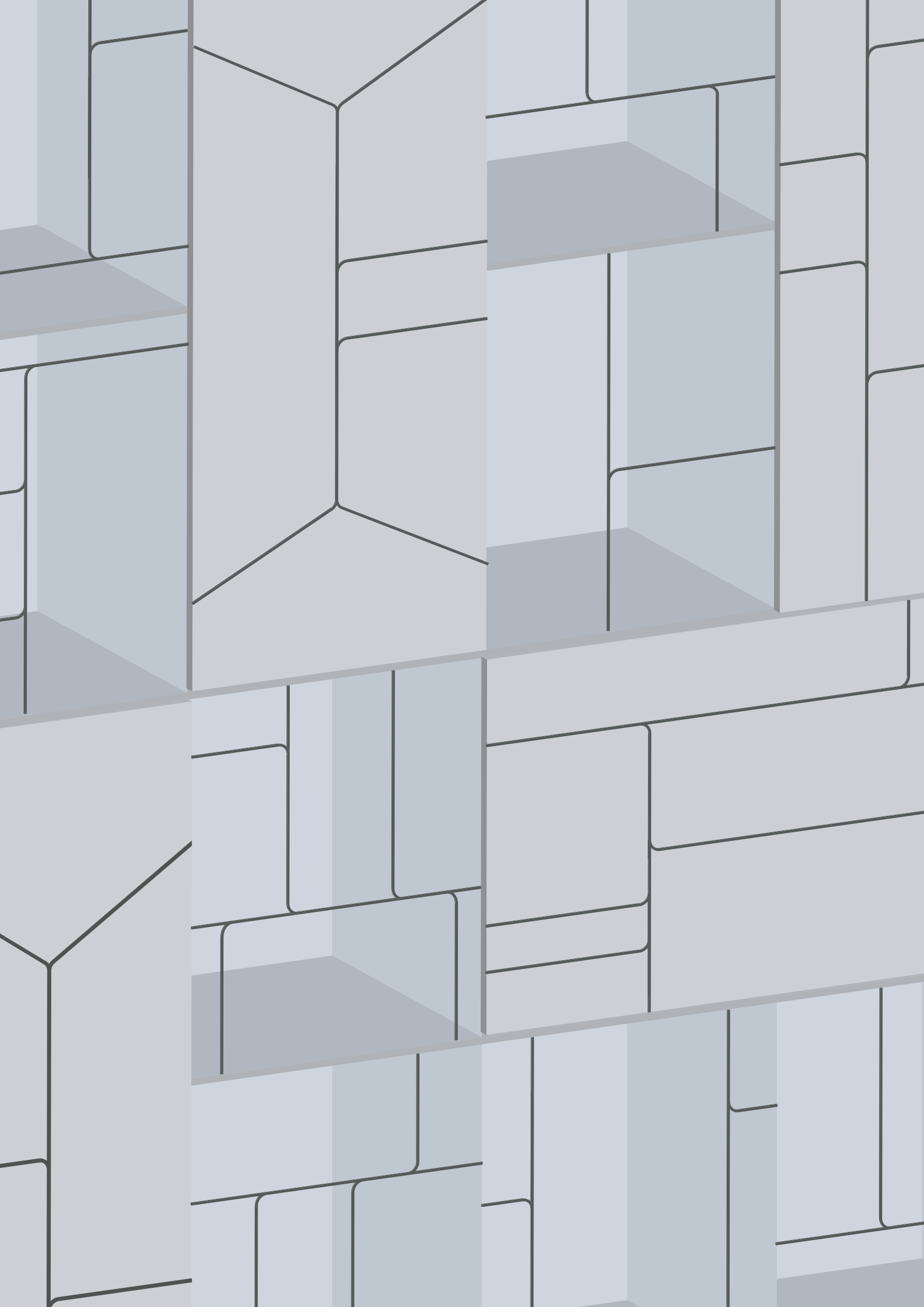

FBS 1324 WAY

design Gio Tiroto

Profili decorativi con biadesivo per porte, sportelli e vetrate

Decorative self-adhesive profiles for doors, cupboard doors and glass partitions

Lunghezza barre 3000 mm
Possibilità di fornire i profili già tagliati a misura
*Standard bars 3000 mm
Cut to size profiles also available*

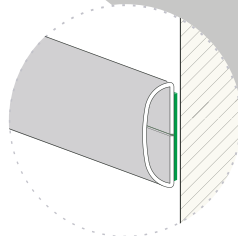

Profilo *Aluminium Profile*

misure in mm
dimensions in mm

CODICE
CODE

○ Plastica riciclata e riciclabile
Recycled and recyclable



○ 100% Alluminio
100% Aluminium

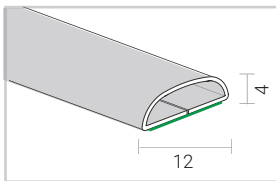

FBS 1324

Accessori *Accessories*

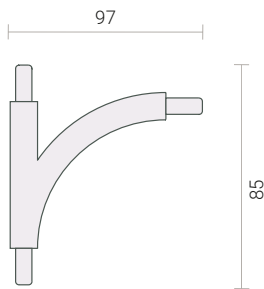

FBS 9550

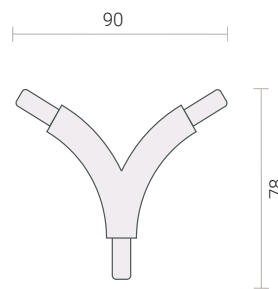

FBS 9551

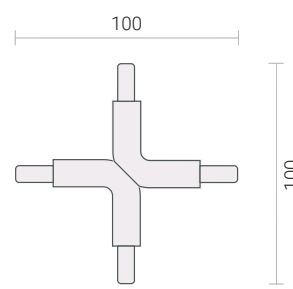

FBS 9552

ISTRUZIONI DI MONTAGGIO *ASSEMBLY INSTRUCTIONS*



1. Pulire accuratamente la superficie.

Thoroughly clean the surface.

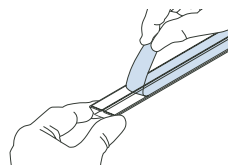

2. Rimuovere il film del biadesivo.

Remove film from the self-adhesive strip.

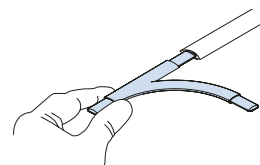

3. Inserire i giunti.

Insert the joints.

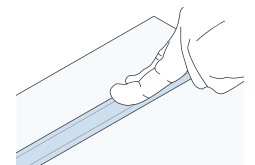

4. Incollare con una leggera pressione il profilo sulla superficie.

Stick the profile onto the surface applying a light pressure.

PROFILI AUTOADESIVI SELF-ADHESIVE PROFILES

Profili decorativi con biadesivo per porte, sportelli e vetrate

Decorative self-adhesive profiles for doors, cupboard doors and glass partitions

Lunghezza barre 3000 mm
Possibilità di fornire i profili già tagliati a misura
Standard bars 3000 mm
Cut to size profiles also available

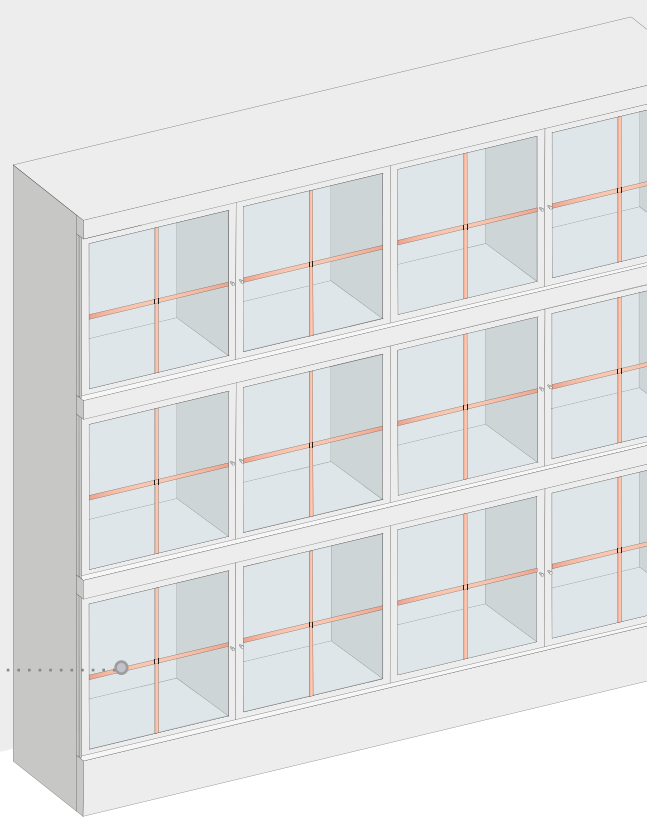
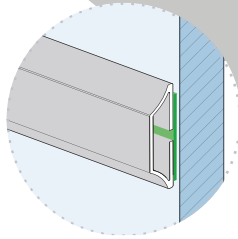

Profilo Aluminium Profile

misure in mm
dimensions in mm

CODICE
CODE

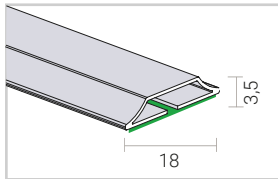

FBS 1193

○ Plastica riciclata e riciclabile
Recycled and recyclable



○ 100% Alluminio
100% Aluminium



Accessori Accessories

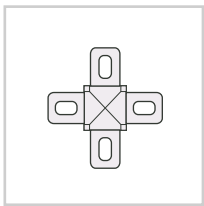

FBS 9193

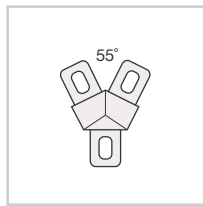

FBS 9194

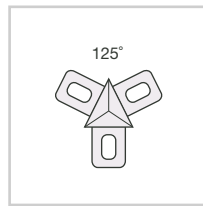

FBS 9195

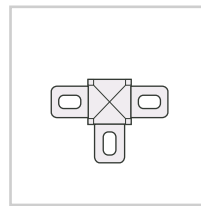

FBS 9196

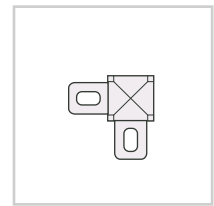

FBS 9197

ISTRUZIONI DI MONTAGGIO ASSEMBLY INSTRUCTIONS



1. Pulire accuratamente la superficie.

Thoroughly clean the surface.

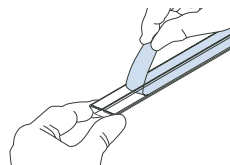

2. Rimuovere il film del biadesivo.

Remove film from the self-adhesive strip.

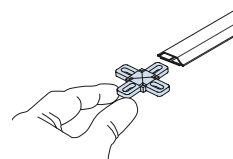

3. Inserire i giunti.

Insert the joints.

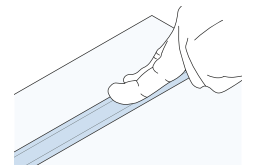

4. Incollare con una leggera pressione il profilo sulla superficie.

Stick the profile onto the surface applying a light pressure.

PROFILI AUTOADESIVI *SELF-ADHESIVE PROFILES*

Profili decorativi con biadesivo
per porte, sportelli e vetrate

*Decorative self-adhesive profiles
for doors, cupboard doors
and glass partitions*

Lunghezza barre 3000 mm
Possibilità di fornire i profili
già tagliati a misura
*Standard bars 3000 mm
Cut to size profiles also
available*

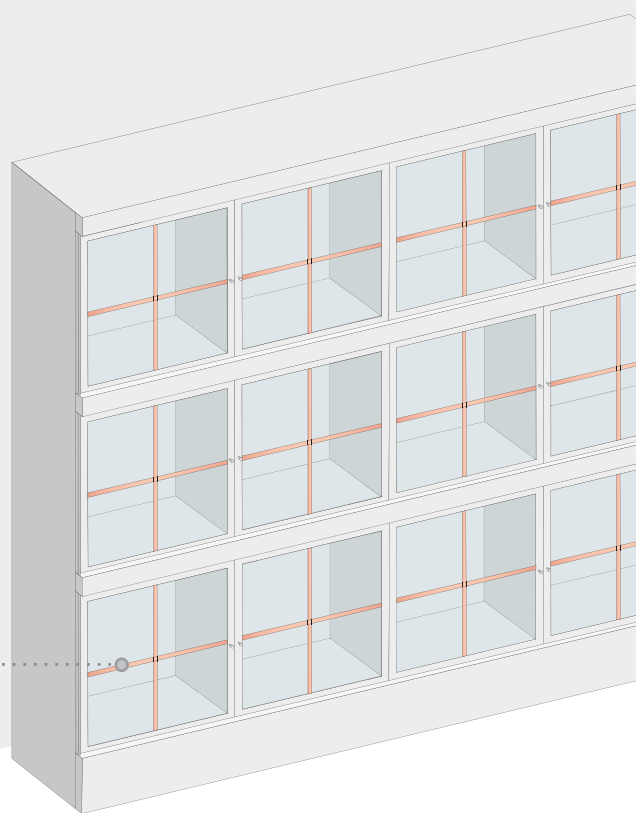
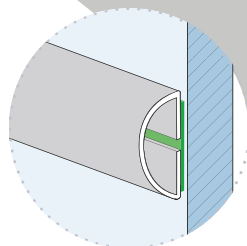

Profilo *Aluminium Profile*

misure in mm
dimensions in mm

CODICE
CODE

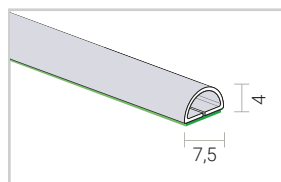

FBS 918

○ **Plastica riciclata e riciclabile**
Recycled and recyclable



○ **100% Alluminio**
100% Aluminium



Accessori *Accessories*

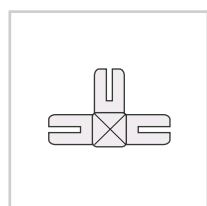

FBS 9052

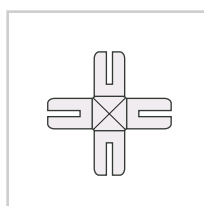

FBS 9053

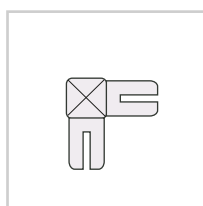

FBS 9055

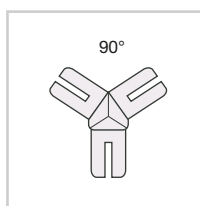

FBS 9056

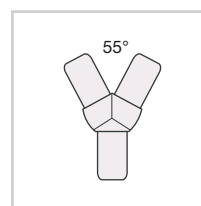

FBS 9057

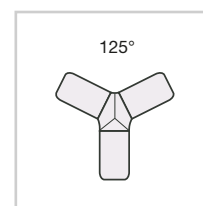

FBS 9058



PROFILI AUTOADESIVI PER VETRO

SELF-ADHESIVE PROFILES FOR GLASS

Profili con biadesivo per porte
e vetro

*Self-adhesive profiles for glass
doors*

Lunghezza barre 3000 mm
Possibilità di fornire i profili
già tagliati a misura

*Standard bars 3000 mm
Cut to size profiles also
available*

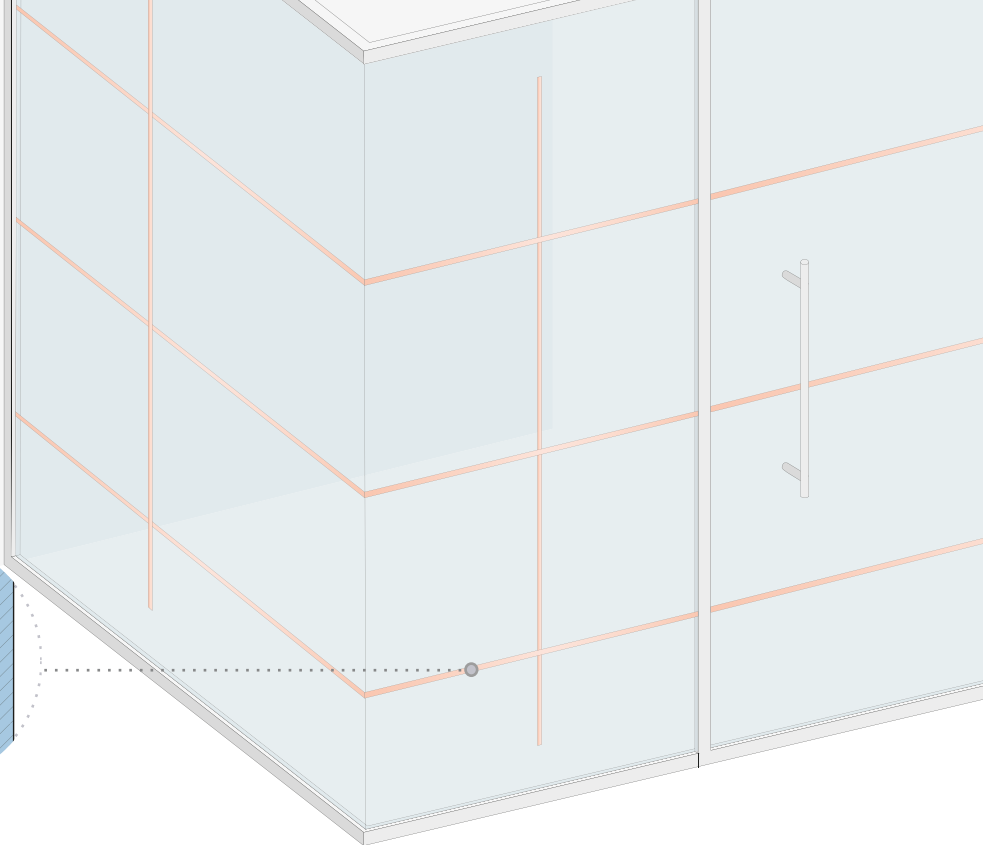
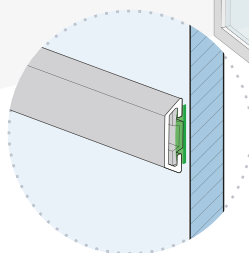

Profilo *Aluminium Profile*

misure in mm
dimensions in mm

CODICE
CODE

CODICE
CODE

CODICE
CODE

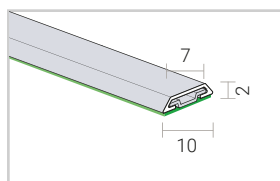

FBS 2038

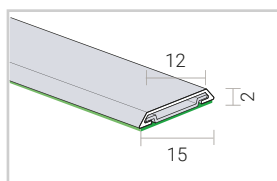

FBS 2040

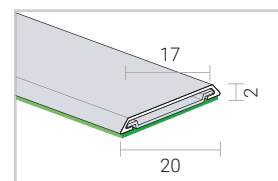

FBS 2041

Accessorio *Accessory*

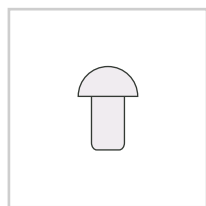

FBS 9237

Terminale tondo per FBS 2038
Round end cup for FBS 2038

ISTRUZIONI DI MONTAGGIO *ASSEMBLY INSTRUCTIONS*

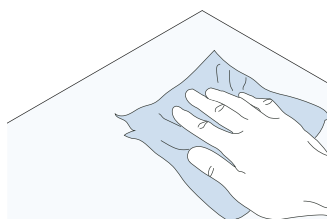

**1. Pulire accuratamente la
superficie.**

*Thoroughly clean the
surface.*

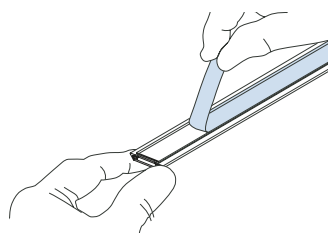

**2. Rimuovere il film del
biadesivo.**

*Remove film from
the self-adhesive strip.*

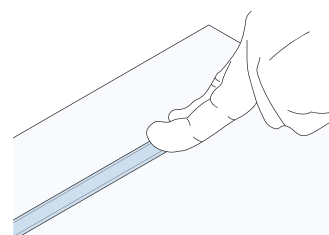

**3. Incollare con una
leggera pressione il profilo
sulla superficie.**

*Stick the profile onto the
surface applying a light
pressure.*

FINITURE
FINISHES

FINITURE FBS 1323 WAY
FINISHES FOR FBS 1323 WAY PROFILE



U7 - olive green



M4 - matt white



L2 - matt black

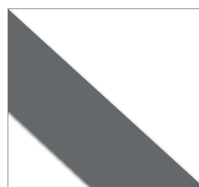

U9 - anthracite

FINITURE PROFILI DECORATIVI PER VETRO CAMERA
FINISHES FOR DECORATIVE PROFILES FOR DOUBLE GLAZING

ANODIZZATI *ANODIZED*



D - chrome



D2 - polished gold



D6 - brass gold

PREVERNICIATI *PREPAINTED*



M3 - polished white

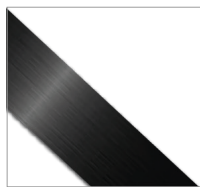

L1 - polished black

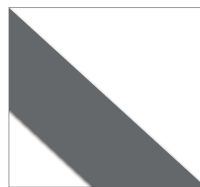

U9 - anthracite

FINITURE PROFILI AUTOADESIVI VETRO PIANO

SELF-ADHESIVE DECORATIVE PROFILES FOR FLAT GLASS

ANODIZZATI ANODIZED



A - brushed



A2 - inox brushed



B - mill finish



B2 - mill inox



SN - sat nat



BR2 - matt bronze



B3 - mill gold



RA - copper



RA2 - polished copper

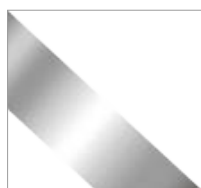

D - chrome



D2 - polished gold



D6 - brass gold

PREVERNICIATI PREPAINTED

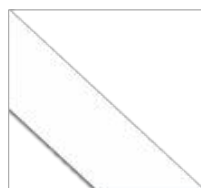

M3 - polished white

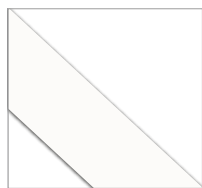

M4 - matt white



U6 - inox



U8 - brushed bronze



U5 - alumatt

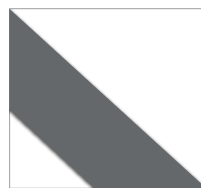

U9 - anthracite



U7 - olive green



L1 - polished black



L2 - matt black



WIND
Disponibile per tutte le finiture
Available for all finishes

Tutti i profili sono forniti di film protettivo
All profiles are supplied with a protective film





SPECIFICHE TECNICHE

TECHNICAL DETAILS

ALLUMINIO ANODIZZATO

ANODIZED ALUMINIUM

Le accattivanti finiture anodizzate derivano da materie prime e da lavorazioni eccellenti che ne garantiscono la qualità e durata nel tempo. Sono ideali per gli ambienti contemporanei dalle linee essenziali poiché si integrano perfettamente con i materiali innovativi e moderni nonché agli elettrodomestici.

The appealing anodized finishing come from excellent raw materials and processing which guarantee their quality and duration in time. They are ideal for contemporary and essential contexts because they match innovative and modern materials perfectly as well as electrical appliances.

TRATTAMENTI PER DECORI E CONNETTORI

DECORS AND CONNECTORS SURFACE TREATMENTS

Quando si tratta di finiture dei decori e connettori, ci sono due opzioni: la Galvanica e la metallizzazione PVD. Mentre la prima è stata la scelta preferita di FBS per anni, la seconda sta rapidamente guadagnando popolarità in molti ambiti di produzione. Presso la nostra azienda, offriamo entrambe le tecniche per soddisfare le diverse esigenze dei nostri clienti. I nostri prodotti Made in Italy sono progettati per resistere alla prova del tempo. Con i nostri trattamenti superficiali, garantiamo una perfetta corrispondenza di colore con le nostre barre in alluminio, creando un prodotto finale di alta qualità.

When it comes to surface treatments for decors and connectors, there are two popular options: galvanic electroplating and PVD coating. While the former has been the preferred choice of FBS Profilati for years, the latter is quickly gaining popularity in many manufacturing circles. At our company, we offer both techniques to meet the varying needs of our customers. Our Made in Italy products are designed to stand the test of time. With our surface treatments, we ensure a perfect color match with our aluminum bars, creating a cohesive and high-quality end product.

ALLUMINIO PREVERNICIATO

PREPAINTED ALUMINIUM

La gamma dei toni pre-verniciati spazia dai colori più neutri come il bianco e il nero, che si prestano ad abbinamenti più classici, fino alle tonalità simil-anodizzate per un interior design contemporaneo e ricercato.

The range of pre-painted shades ranges from more neutral colours such as white and black, suitable for more classic combinations, to simil-anodised finishes for a contemporary and sophisticated interior design.

ALLUMINIO MICROFORATO

PERFORATED ALUMINIUM

Con aperture rotonde e sfalsate, il metallo perforato è un materiale industriale utilizzato in numerosi progetti di interni. Con la sua trasparenza, il materiale funziona bene con altri elementi e aiuta a creare profondità. È apprezzato soprattutto per la sua qualità grafica e l'effetto ottico che produce quando viene stratificato.

With round and staggered openings, perforated metal is an industrial material that is used in a number of interior projects.

With its transparency, the material works well with other elements and helps create depth. It is mostly appreciated for its graphic quality and the optical effect it produces when layered.

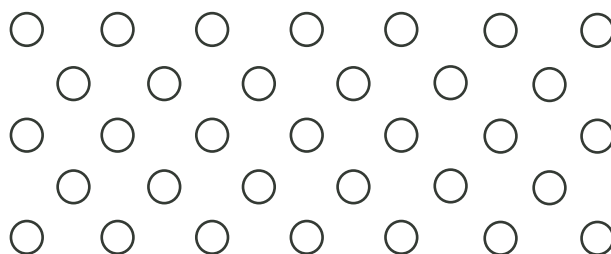

CALANDRA MANUALE

MANUAL BENDING MACHINE

misure in mm
dimensions in mm

CODICE
CODE

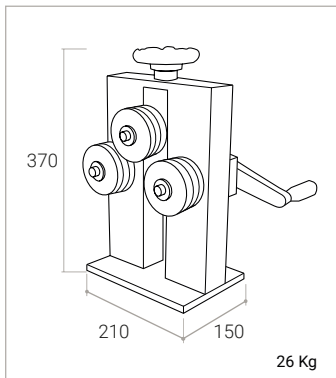

FBS 7710

ADATTA PER I SEGUENTI PROFILI:
SUITABLE FOR THE FOLLOWING PROFILES:

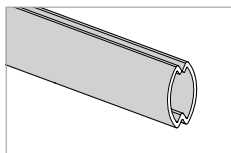

FBS 1322

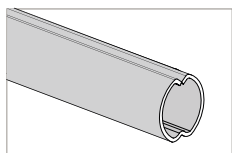

FBS 1062

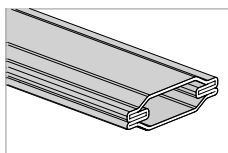

FBS 1251

Accessori per FBS 1062
Accessories for FBS 1062

Accessori per FBS 1251
Accessories for FBS 1251

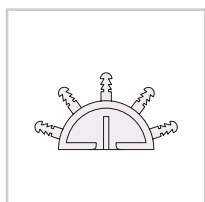

FBS 9266

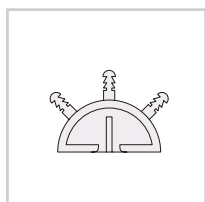

FBS 9265

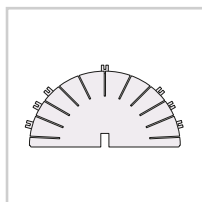

FBS 9249

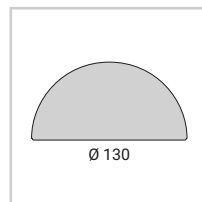

FBS 9351

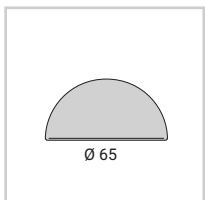

FBS 9362

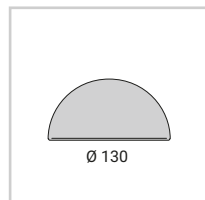

FBS 9363

Esempi *Examples*

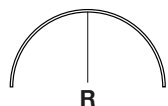

R

Minimum radius:
150 mm

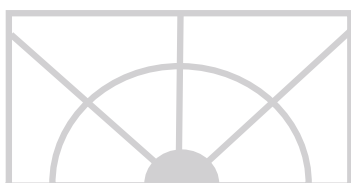

SCOPRI TUTTI I NOSTRI PRODOTTI SU
DISCOVER OUR FULL PRODUCT RANGE AT

fbsprofilati.it

COPYRIGHT 2023
FBSProfilati srl

Edizione 03/2023



50 G

50 F

50 C

50 B

4 B

Il presente catalogo è di proprietà
di FBSProfilati S.r.l. Tutti i diritti riservati.
Sono vietate riproduzioni e alterazione.
Illustrazioni e dati contenuti in questo catalogo
hanno valore indicativo. Per una corretta installazione
fare riferimento ai manuali.

*This catalogue is property of FBSProfilati S.r.l.
All rights reserved.*

*Reproduction and Alterations are forbidden.
All illustrations and information in this catalogue
are indicative. For a correct installation please refer
to the assembly instruction manuals.*



PROFILATI ITALIANI

FBSProfilati srl

Via Edison, 251
20019 Settimo Milanese MI - Italia

phone: +39 024564768 | +39 0248916411

info@fbsprofilati.it

fbsprofilati.it